

**U.S. ALUMINUM WIDE STILE SERIES 550AT DOOR SYSTEM**

DOOR SWING CHART

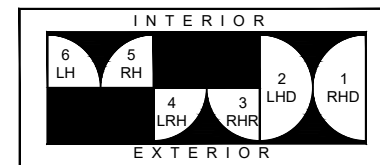

STANDARD ABBREVIATIONS

- RO ROUGH OPENING
- FD FRAME DIMENSION
- DLO DAYLIGHT OPENING
- DO DOOR OPENING
- DD DOOR DIMENSION
- SMC SURFACE MOUNTED CLOSER
- OHCC OVERHEAD CONCEALED CLOSER

**STRUCTURAL DISCLAIMER:**

ALL CUSTOMERS WHO IN ANY WAY UTILIZE THIS PRODUCT ARE SOLELY RESPONSIBLE TO CONSULT A STRUCTURAL ENGINEER TO DETERMINE THE SUITABILITY OF THE PRODUCT FOR THE INTENDED USE AND SITE CONDITIONS. ALL INSTALLERS MUST BE QUALIFIED AND HAVE PROFESSIONAL KNOWLEDGE ABOUT COMPLIANCE WITH LOCAL, STATE AND FEDERAL REGULATIONS, SAFETY FACTORS, AND THE APPROPRIATE CHOICE OF FIXING MATERIAL AND PROCEDURES.

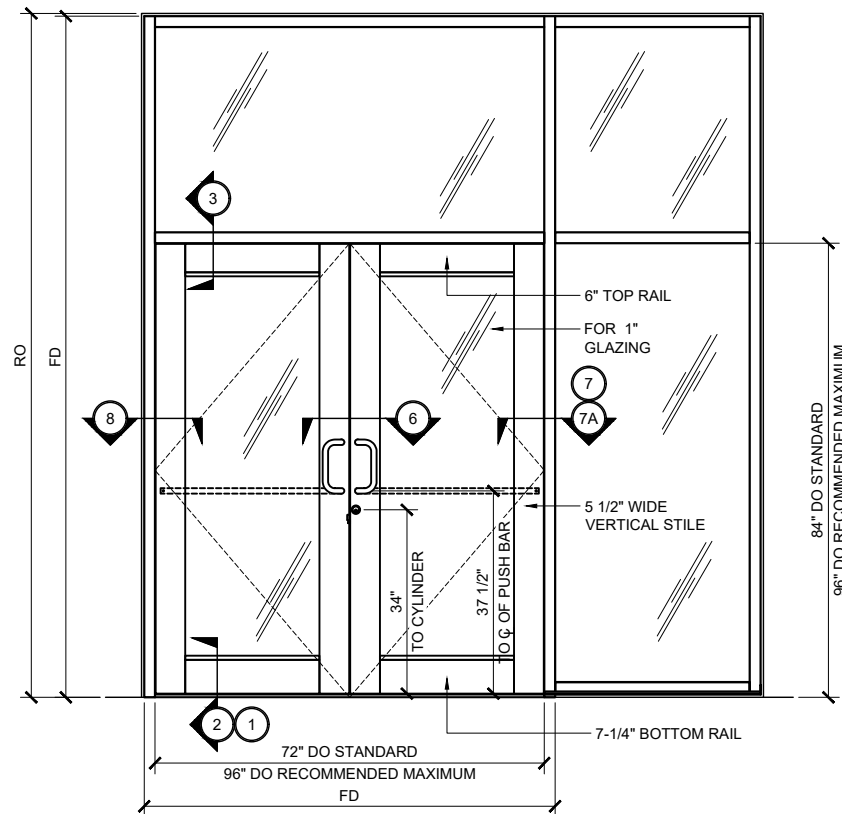

**WIDE STILE SERIES 550AT DOOR TYP. ELEVATION**  
(DOUBLE DOOR @ TRANSOM FRAME) 3/4" = 1'-0"

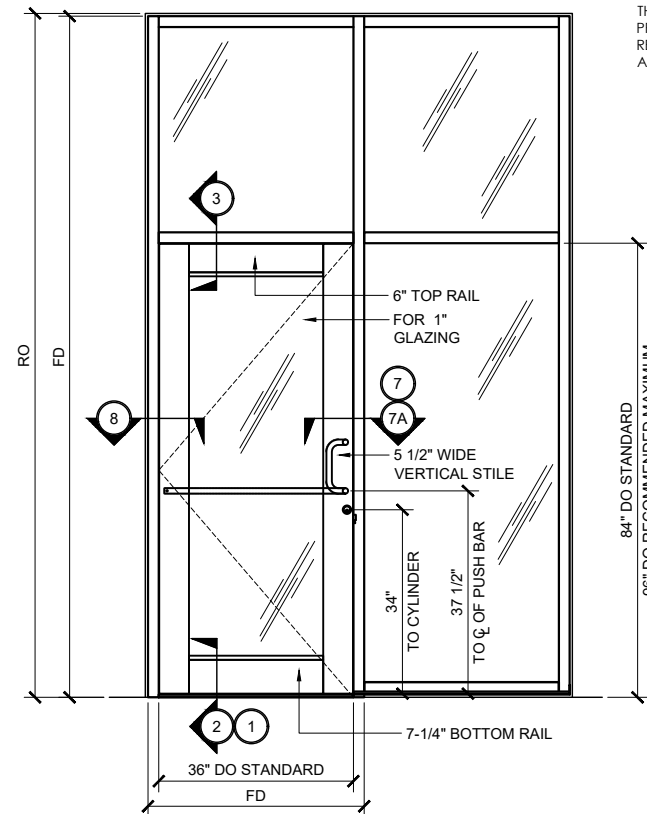

**WIDE STILE SERIES 550AT DOOR TYP. ELEVATION**  
(SINGLE DOOR @ TRANSOM FRAME) 3/4" = 1'-0"

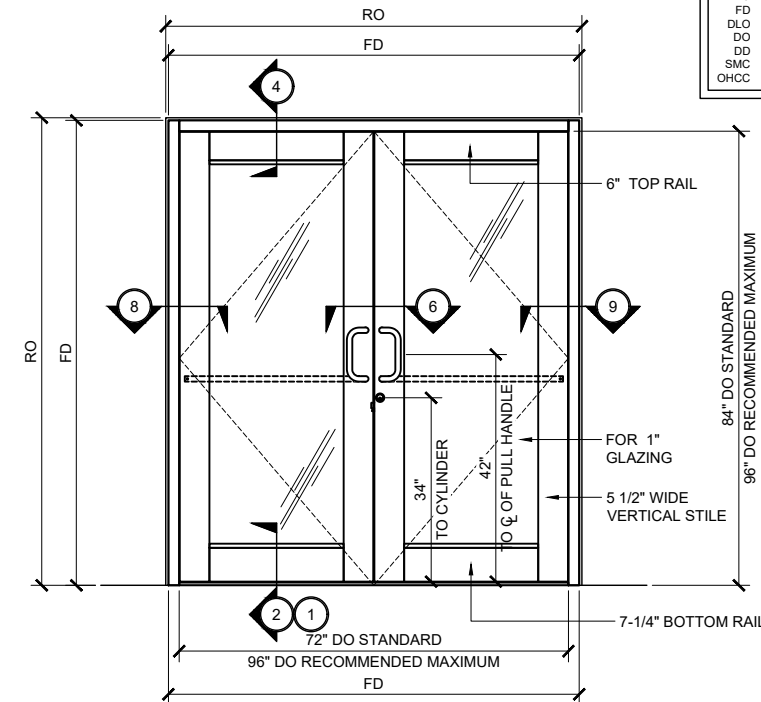

**WIDE STILE SERIES 550AT DOOR TYP. ELEVATION**  
(DOUBLE DOOR @ UP / OVER FRAME) 3/4" = 1'-0"

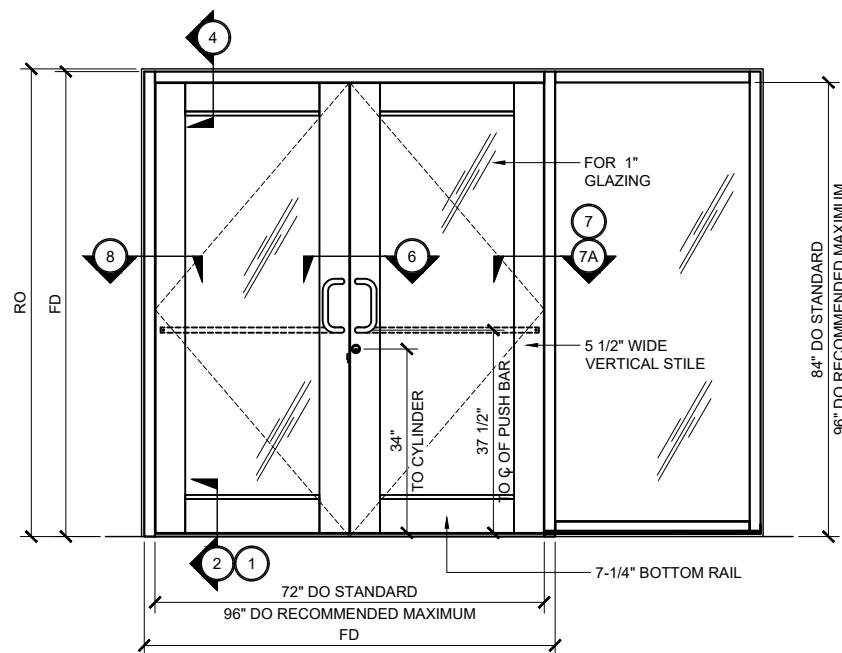

**WIDE STILE SERIES 550AT DOOR TYP. ELEVATION**  
(DOUBLE DOOR @ UP / OVER FRAME WITH SIDELITE) 3/4" = 1'-0"

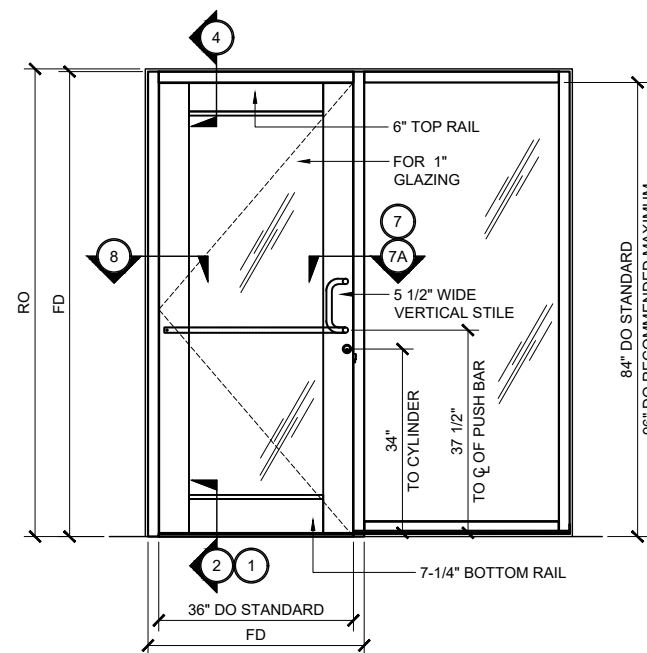

**WIDE STILE SERIES 550AT DOOR TYP. ELEVATION**  
(SINGLE DOOR @ UP / OVER FRAME WITH SIDELITE) 3/4" = 1'-0"

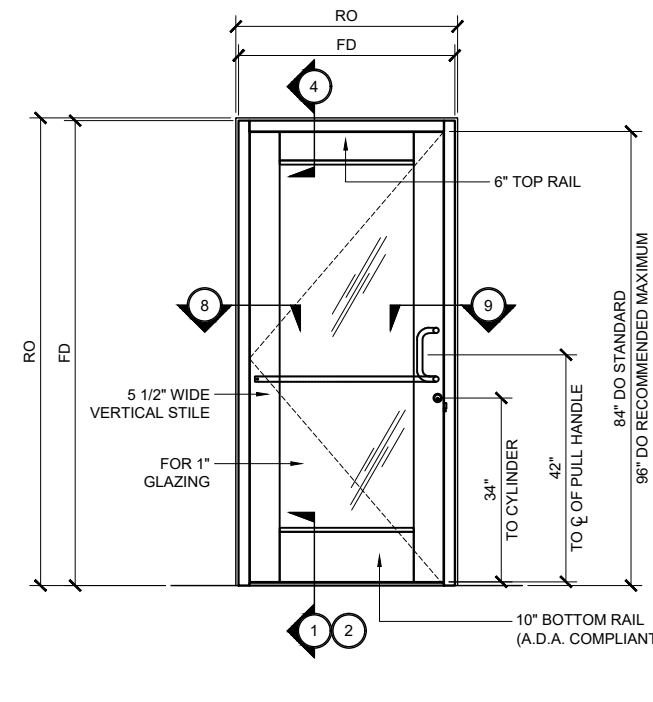

**WIDE STILE SERIES 550AT DOOR TYP. ELEVATION**  
(SINGLE DOOR @ UP / OVER FRAME) (SHOWN W/ 10" BOTTOM RAIL) 3/4" = 1'-0"

Revisions By:

TMG 10/20/17

**U.S. ALUMINUM**  
C.R. LAURENCE CO. ARCHITECTURAL PRODUCTS  
2503 E. Vernon Avenue, Los Angeles, CA 90058-1897  
PH: (800) 421-6144 FX: (800) 857-7501 www.crlaurence.com

Description:  
U.S. ALUMINUM  
WIDE STILE SERIES 550AT  
DOOR SYSTEM

Drawn By: RPD

Date: 01/17/17

Scale: AS NOTED

File Name: 550AT.dwg

Sheet

U.S. ALUMINUM WIDE STILE SERIES 550AT DOOR SYSTEM

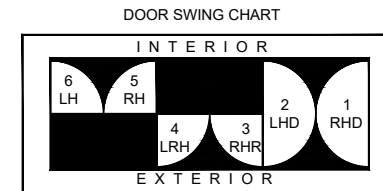

STANDARD ABBREVIATIONS

- RO ROUGH OPENING
- FD FRAME DIMENSION
- DLO DAYLIGHT OPENING
- DO DOOR OPENING
- DD DOOR DIMENSION
- SMC SURFACE MOUNTED CLOSER
- OHCC OVERHEAD CONCEALED CLOSER

Revisions By:

|     |          |
|-----|----------|
| TMG | 10/20/17 |
|     |          |
|     |          |

**U.S. ALUMINUM**  
C.R.LAURENCE CO. ARCHITECTURAL PRODUCTS  
2503 E. Vernon Avenue, Los Angeles, CA 90058-1897  
PH: (800) 421-1144 FX: (800) 857-7501 www.crlaurence.com

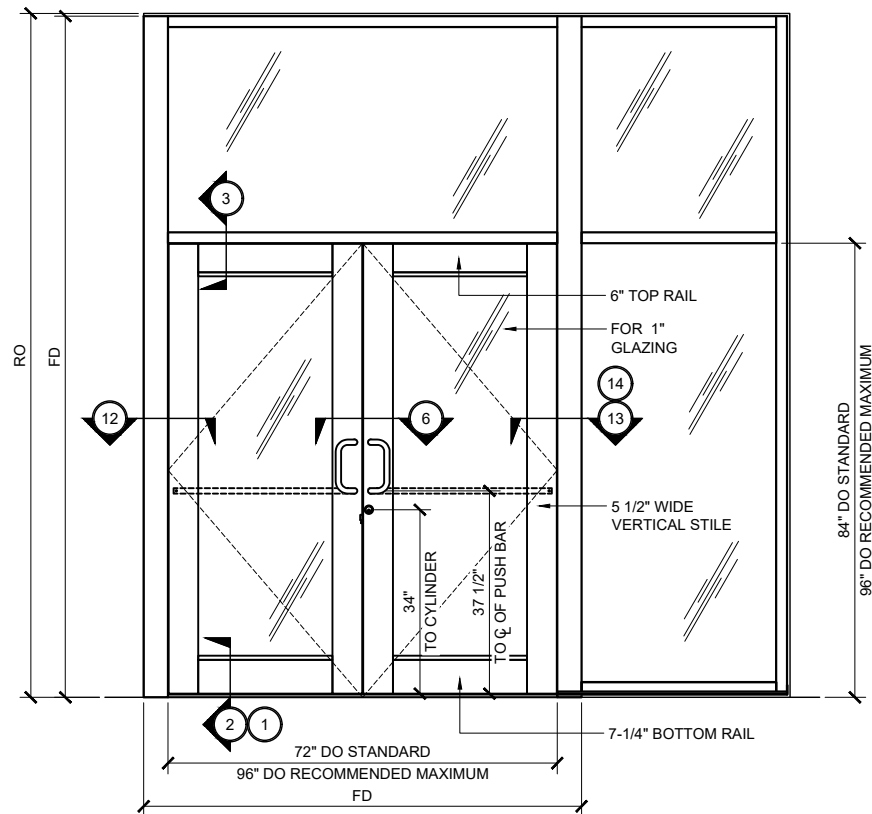

**WIDE STILE SERIES 550AT DOOR TYP. ELEVATION**  
(DOUBLE DOOR @ TRANSOM FRAME ) 3/4" = 1'-0"

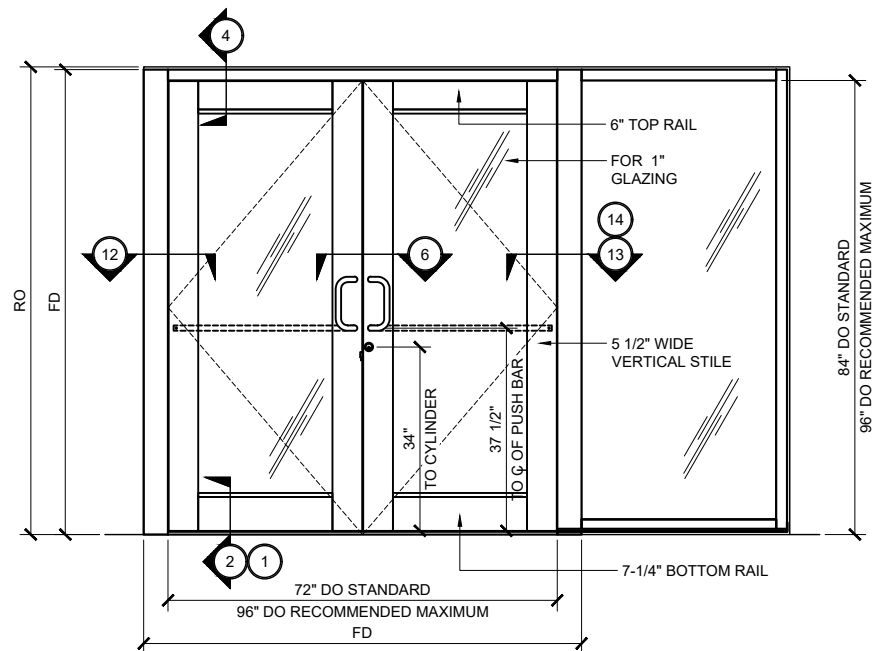

**WIDE STILE SERIES 550AT DOOR TYP. ELEVATION**  
(DOUBLE DOOR @ UP / OVER FRAME WITH SIDELITE) 3/4" = 1'-0"

Description:  
U.S. ALUMINUM  
WIDE STILE SERIES 550AT  
DOOR SYSTEM

Drawn By: RPD  
Date: 01/17/17  
Scale: AS NOTED  
File Name: 550AT.dwg

Sheet

U.S. ALUMINUM WIDE STILE SERIES 550AT DOOR SYSTEM

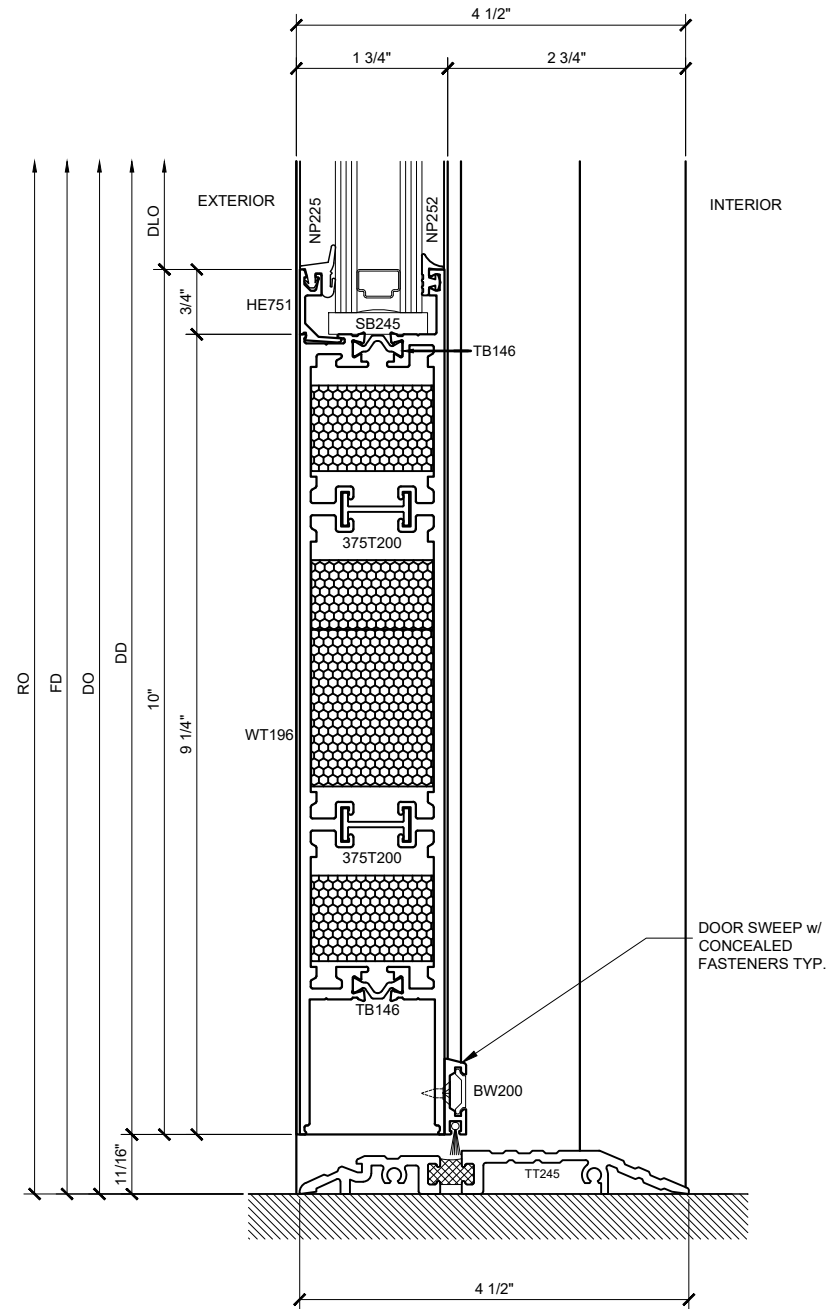

SECTION DETAIL @ 10" DOOR SILL ①  
SCALE: FULL SIZE

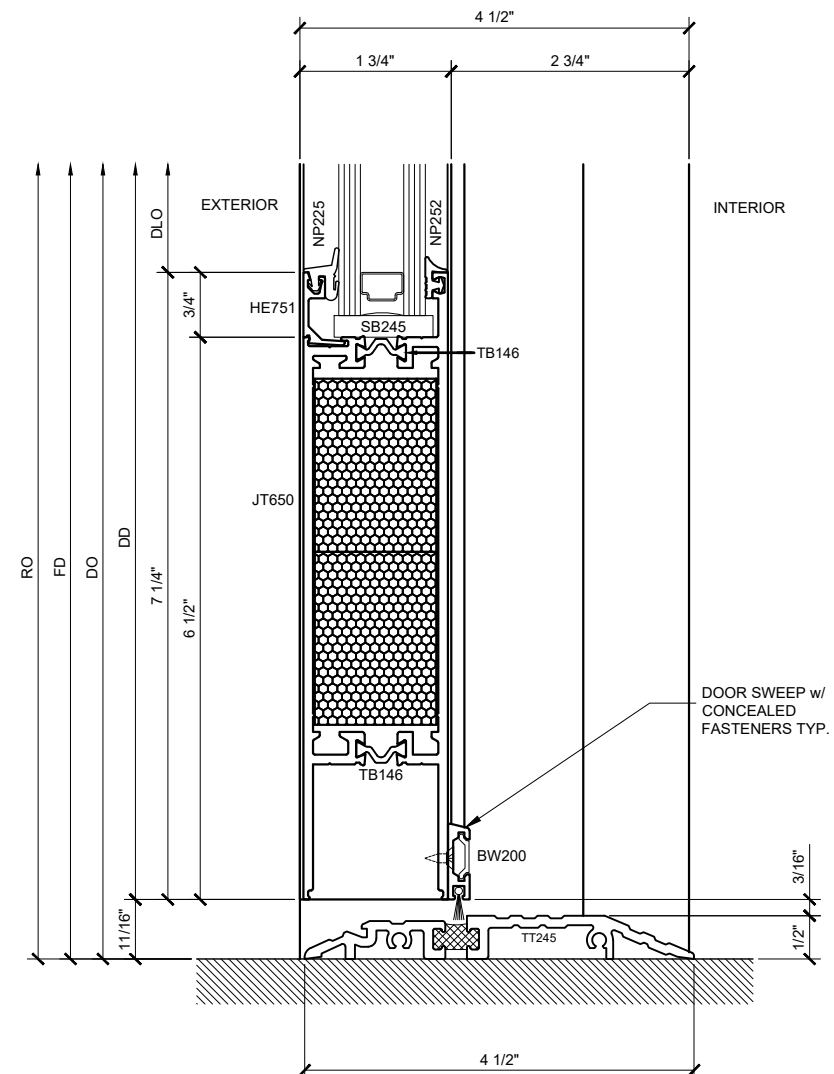

SECTION DETAIL @ 7" DOOR SILL ②  
SCALE: FULL SIZE

WIDE STILE OFFSET-HUNG SERIES 550AT DOOR DETAILS  
SHOWN WITH SERIES IT451 STOREFRONT SYSTEM

Revisions By:  
TMG 10/20/17

**CAL**  
**ALUMINUM**  
C.R. LAURENCE CO. ARCHITECTURAL PRODUCTS  
2503 E. Vernon Avenue, Los Angeles, CA 90058-1897  
PH: (800) 421-6144 FX: (800) 987-7501 www.crlaurence.com

Description:  
U.S. ALUMINUM  
WIDE STILE SERIES 550AT  
DOOR SYSTEM

Drawn By: RPD  
Date: 01/17/17  
Scale: AS NOTED  
File Name: 550AT.dwg

Sheet

1.01

U.S. ALUMINUM WIDE STILE SERIES 550AT DOOR SYSTEM

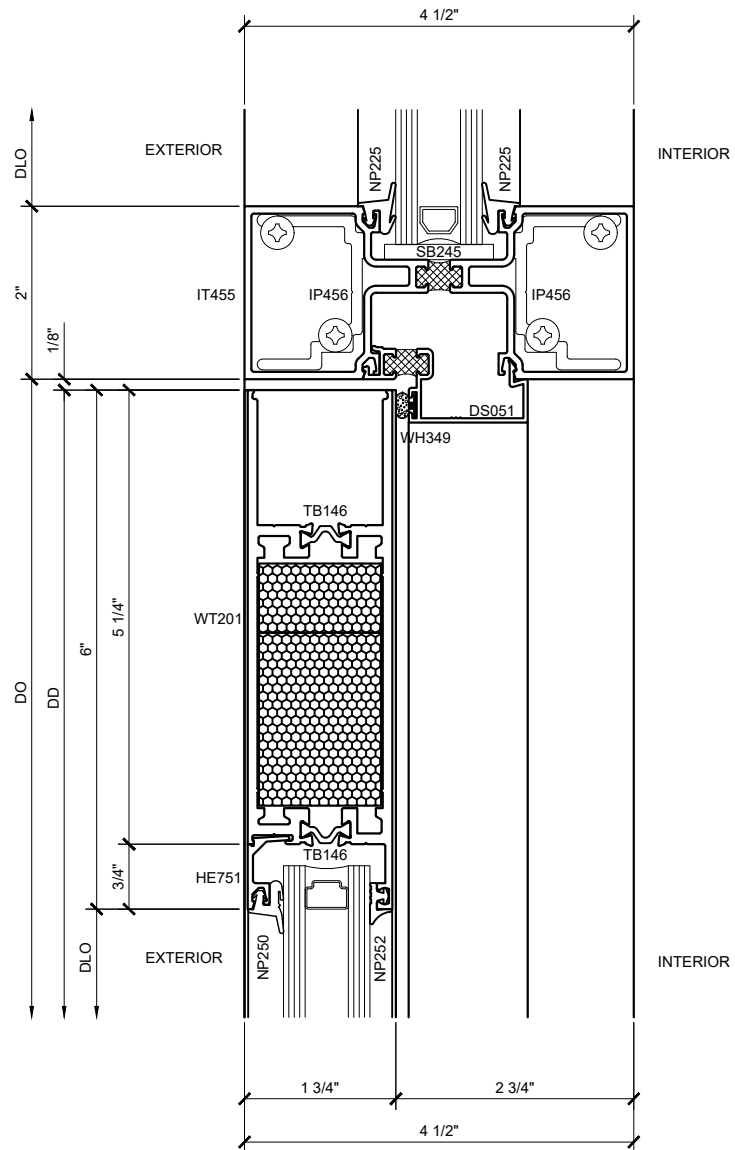

SECTION DETAIL @ TRANSOM 3  
SCALE: FULL SIZE

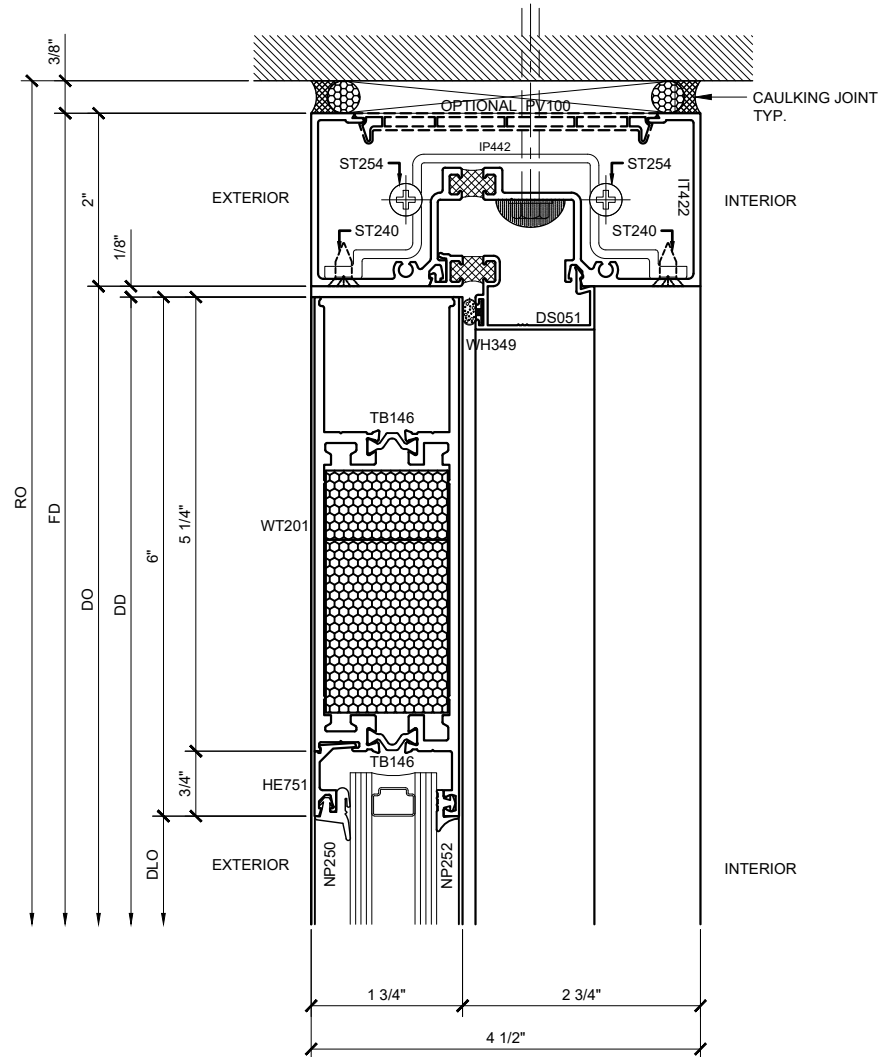

SECTION DETAIL @ DOOR HEAD 4  
SCALE: FULL SIZE

**WIDE STILE OFFSET-HUNG SERIES 550AT DOOR DETAILS**  
SHOWN WITH SERIES IT451 STOREFRONT SYSTEM

Revisions By:  
TMG 10/20/17

**CAL**  
**ALUMINUM**  
C.R. LAURENCE CO. ARCHITECTURAL PRODUCTS  
2503 E. Vernon Avenue, Los Angeles, CA 90058-1897  
PH: (800) 421-6144 FX: (800) 857-7501 www.crlaurence.com

Description:  
U.S. ALUMINUM  
WIDE STILE SERIES 550AT  
DOOR SYSTEM

Drawn By: RPD  
Date: 01/17/17  
Scale: AS NOTED  
File Name: 550AT.dwg

Sheet

1.02

U.S. ALUMINUM WIDE STILE SERIES 550AT DOOR SYSTEM

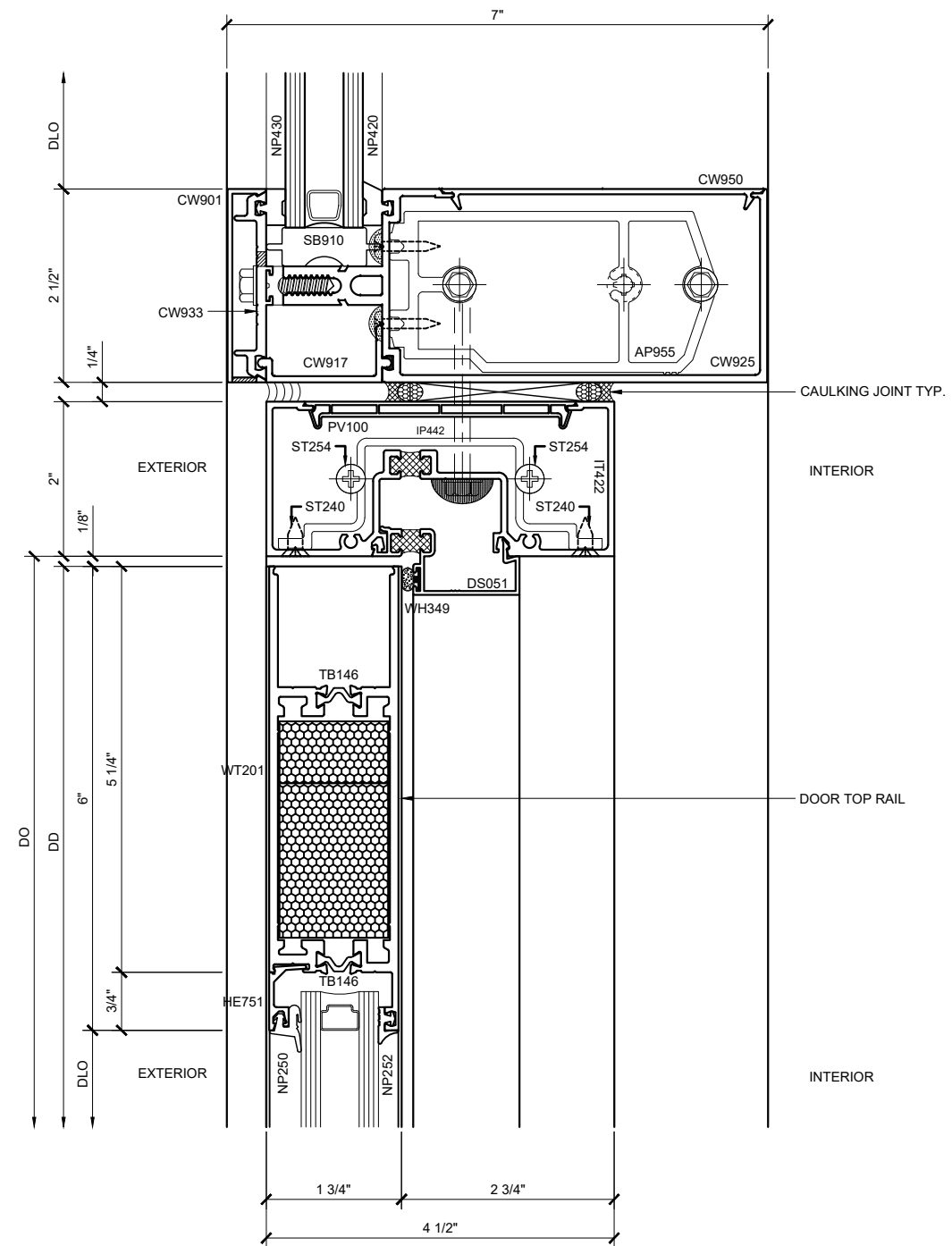

SECTION DETAIL @ DOOR HEAD (4A)  
SCALE: FULL SIZE

WIDE STILE OFFSET-HUNG SERIES 550AT DOOR DETAILS  
SHOWN WITH SERIES 3250 CURTAIN WALL SYSTEM

Revisions By:  
TMG 10/20/17

**CAL**  
**ALUMINUM**  
C.R. LAURENCE CO. ARCHITECTURAL PRODUCTS  
2503 E. Vernon Avenue, Los Angeles, CA 90058-1897  
PH: (800) 421-6144 FX: (800) 857-7501 www.crlaurence.com

Description:  
U.S. ALUMINUM  
WIDE STILE SERIES 550AT  
DOOR SYSTEM

Drawn By: RPD  
Date: 01/17/17  
Scale: AS NOTED  
File Name: 550AT.dwg

Sheet

1.03

U.S. ALUMINUM WIDE STILE SERIES 550AT DOOR SYSTEM

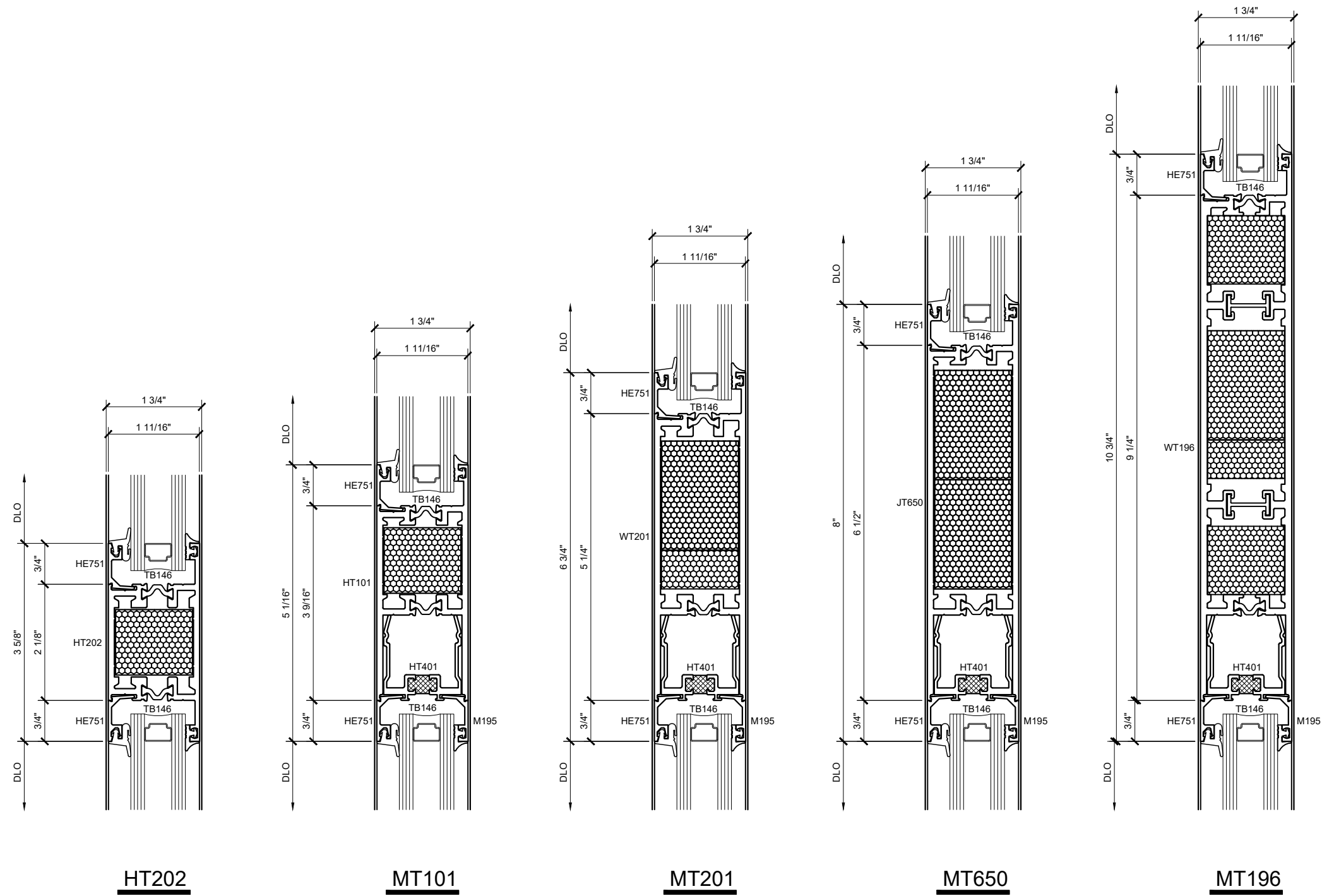

Revisions By:

TMG 10/20/17

**CAL**  
U.S. ALUMINUM  
C.R. LAURENCE CO. ARCHITECTURAL PRODUCTS  
2503 E. Vernon Avenue, Los Angeles, CA 90058-1897  
PH: (800) 421-6144 FX: 800-857-7501 www.crlaurence.com

Description:  
U.S. ALUMINUM  
WIDE STILE SERIES 550AT  
DOOR SYSTEM

Drawn By: RPD

Date: 01/17/17

Scale: AS NOTED

File Name: 550AT.dwg

Sheet

1.04

**NARROW STILE OFFSET-HUNG SERIES 550AT DOOR MUNTINS**

**U.S. ALUMINUM WIDE STILE SERIES 550AT DOOR SYSTEM**

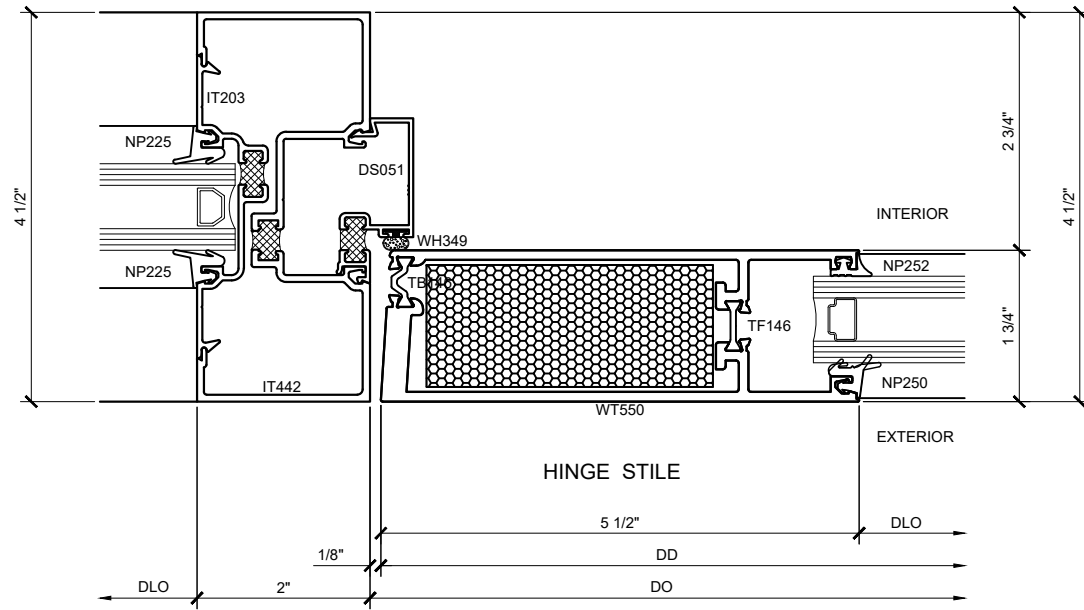

**SECTION DETAIL @ DOOR HINGE JAMB** (5)  
SCALE: FULL SIZE

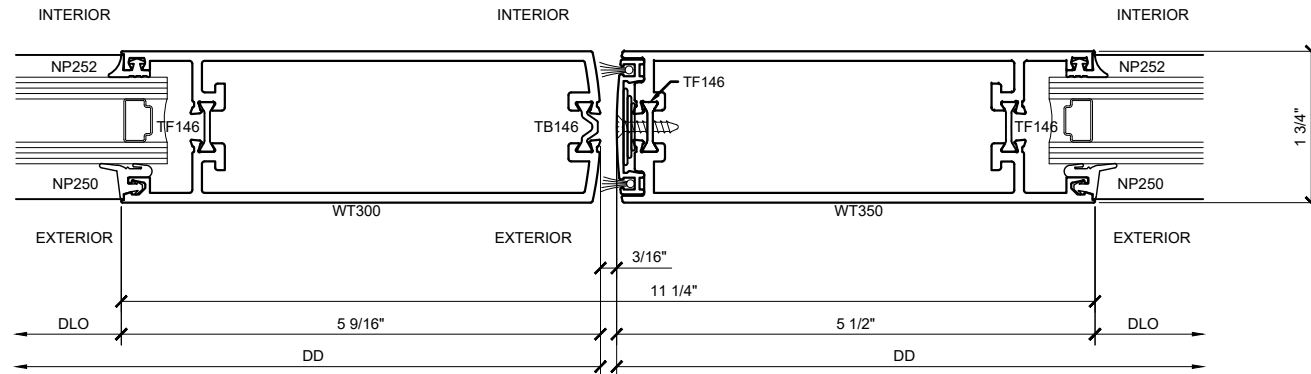

**SECTION DETAIL @ MEETING STILES** (6)  
SCALE: FULL SIZE

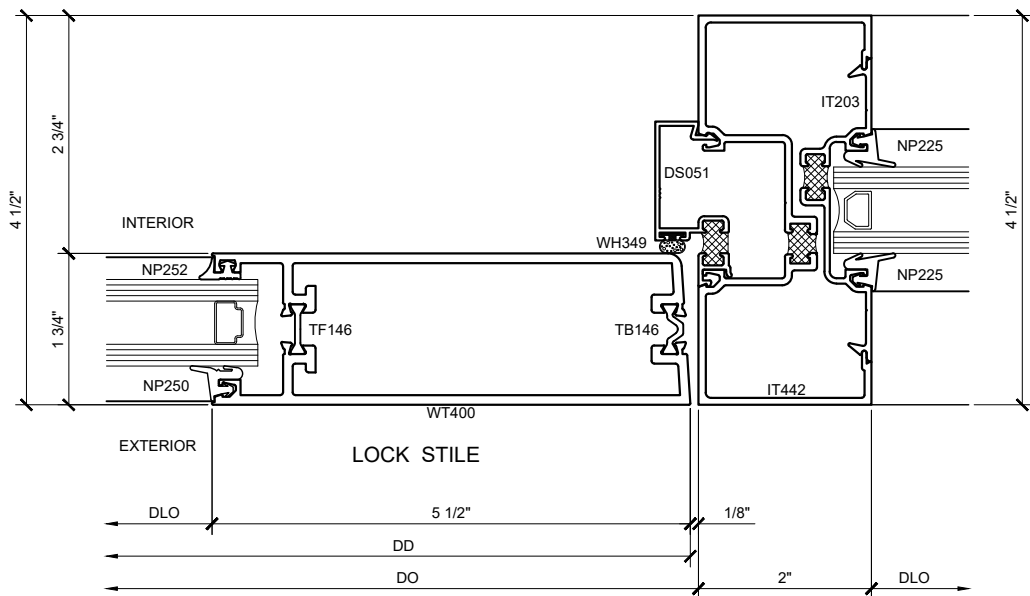

**SECTION DETAIL @ DOOR JAMB** (7)  
SCALE: FULL SIZE

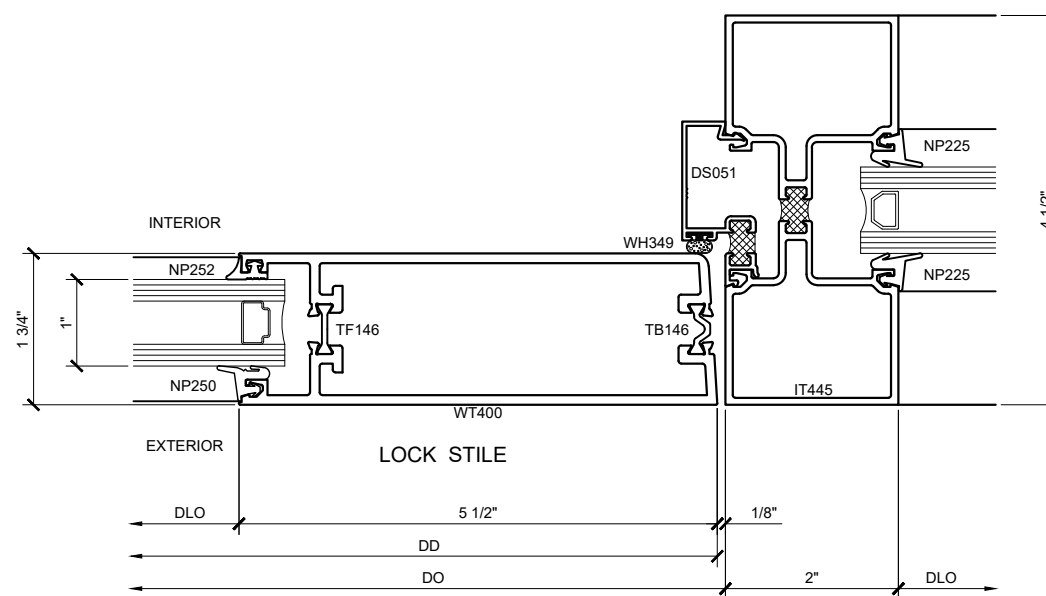

**SECTION DETAIL @ DOOR JAMB** (7A)  
SCALE: FULL SIZE

**WIDE STILE OFFSET-HUNG SERIES 550AT DOOR DETAILS**  
SHOWN WITH SERIES IT451 STOREFRONT SYSTEM

Revisions By:  
TMG 10/20/17

**U.S. ALUMINUM**  
C.R. LAURENCE CO. ARCHITECTURAL PRODUCTS  
2503 E. Vernon Avenue, Los Angeles, CA 90058-1897  
PH: (800) 421-6144 FX: (800) 387-7301 www.crlaurence.com

Description:  
U.S. ALUMINUM  
WIDE STILE SERIES 550AT  
DOOR SYSTEM

Drawn By: RPD  
Date: 01/17/17  
Scale: AS NOTED  
File Name: 550AT.dwg

Sheet

2.01

U.S. ALUMINUM WIDE STILE SERIES 550AT DOOR SYSTEM

Revisions By:

TMG 10/20/17

**CAL**  
**ALUMINUM**  
 C.R. LAURENCE CO. ARCHITECTURAL PRODUCTS  
 2503 E. Vernon Avenue, Los Angeles, CA 90058-1897  
 PH: (800) 421-6144 FX: (800) 857-7501 www.crlaurence.com

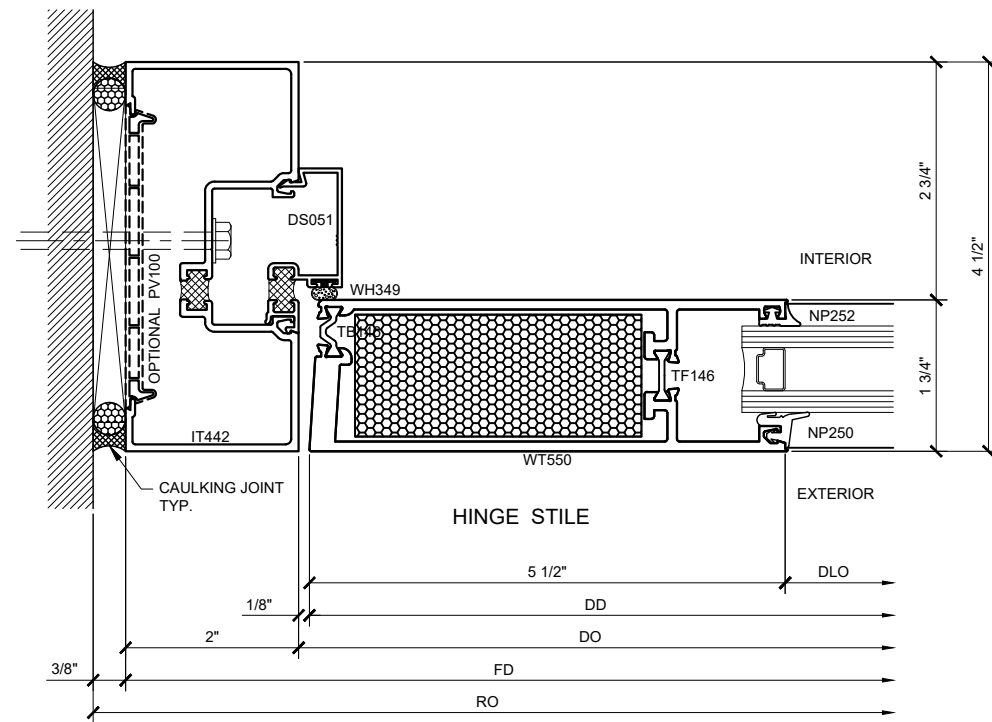

SECTION DETAIL @ DOOR HINGE JAMB

8

SCALE: FULL SIZE

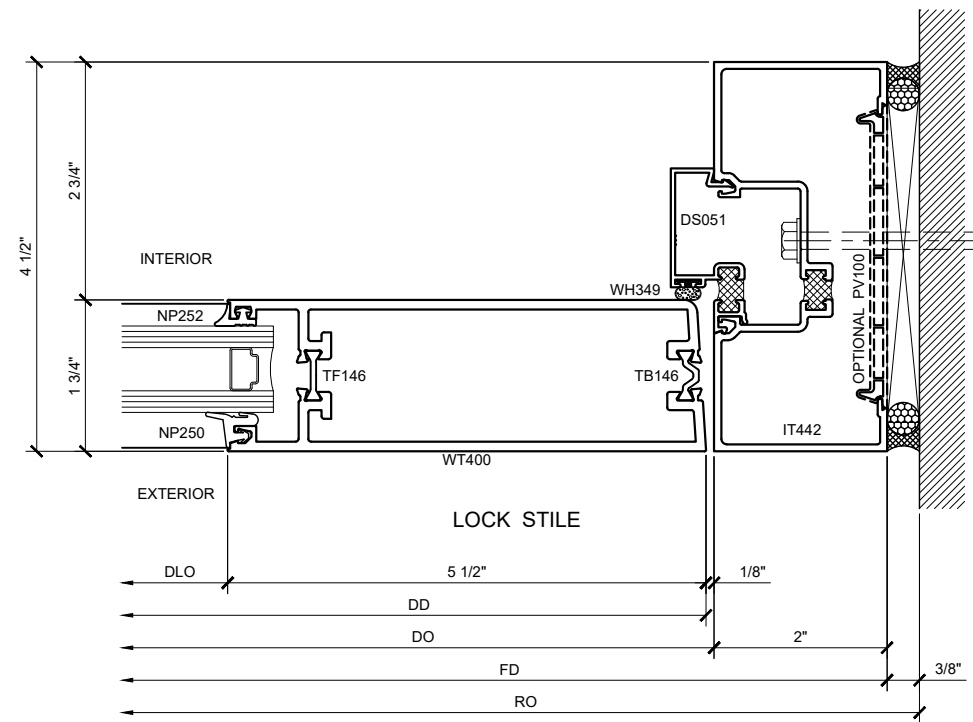

SECTION DETAIL @ DOOR JAMB

9

SCALE: FULL SIZE

Description:  
 U.S. ALUMINUM  
 WIDE STILE SERIES 550AT  
 DOOR SYSTEM

Drawn By: RPD

Date: 01/17/17

Scale: AS NOTED

File Name: 550AT.dwg

Sheet

2.02

WIDE STILE OFFSET-HUNG SERIES 550AT DOOR DETAILS  
 SHOWN WITH SERIES IT451 STOREFRONT SYSTEM



U.S. ALUMINUM WIDE STILE SERIES 550AT DOOR SYSTEM

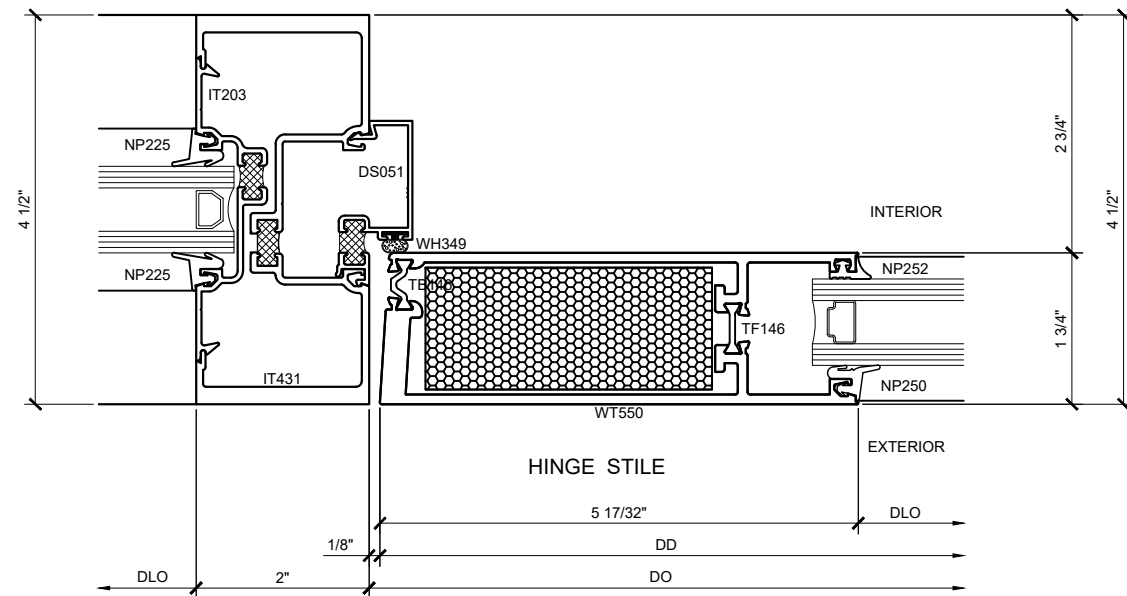

SECTION DETAIL @ DOOR HINGE JAMB

10

SCALE: FULL SIZE

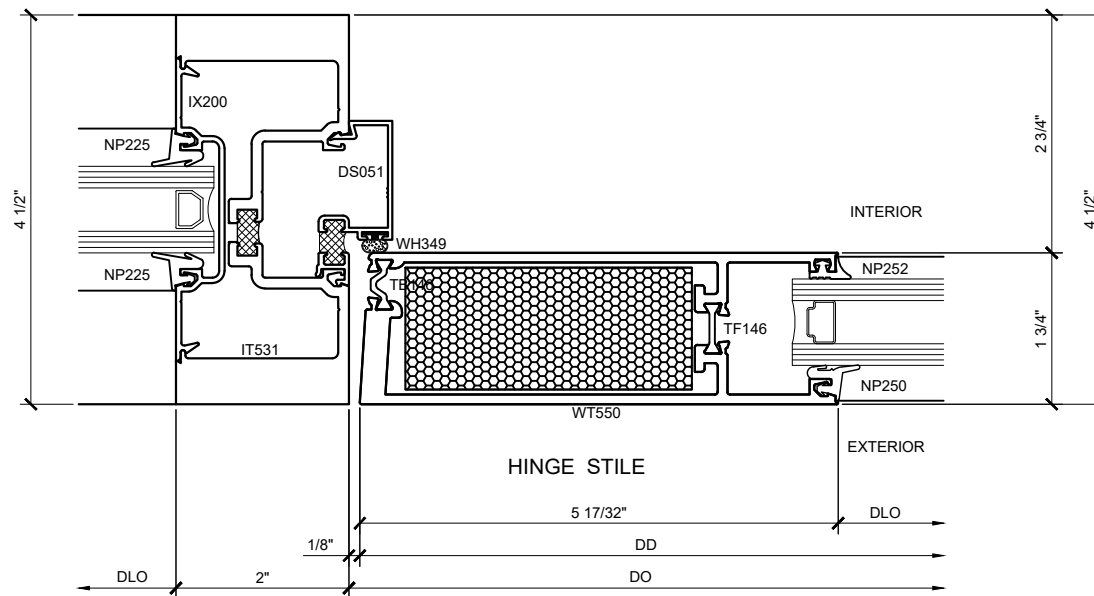

SECTION DETAIL @ DOOR HINGE JAMB

11

SCALE: FULL SIZE

WIDE STILE OFFSET-HUNG SERIES 550AT DOOR DETAILS  
SHOWN WITH SERIES IT451 STOREFRONT SYSTEM

Revisions By:

TMG 10/20/17

**CAL**  
**ALUMINUM**  
C.R. LAURENCE CO. ARCHITECTURAL PRODUCTS  
2503 E. Vernon Avenue, Los Angeles, CA 90058-1897  
PH: (800) 421-6144 FX: (800) 857-7501 www.crlaurence.com

Description:  
U.S. ALUMINUM  
WIDE STILE SERIES 550AT  
DOOR SYSTEM

Drawn By: RPD

Date: 01/17/17

Scale: AS NOTED

File Name: 550AT.dwg

Sheet

2.03

U.S. ALUMINUM WIDE STILE SERIES 550AT DOOR SYSTEM

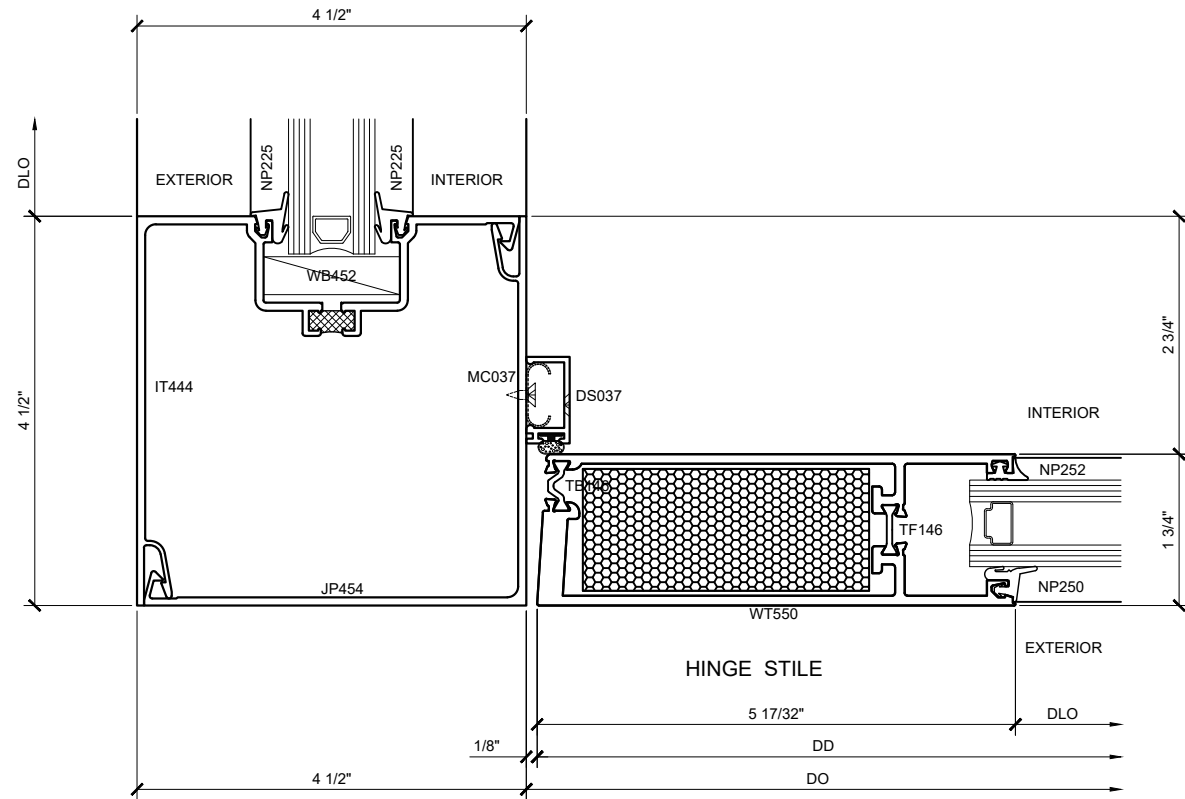

SECTION DETAIL AT WIDE HINGE STYLE  
CORNER VERTICAL (12)  
SCALE: FULL SIZE

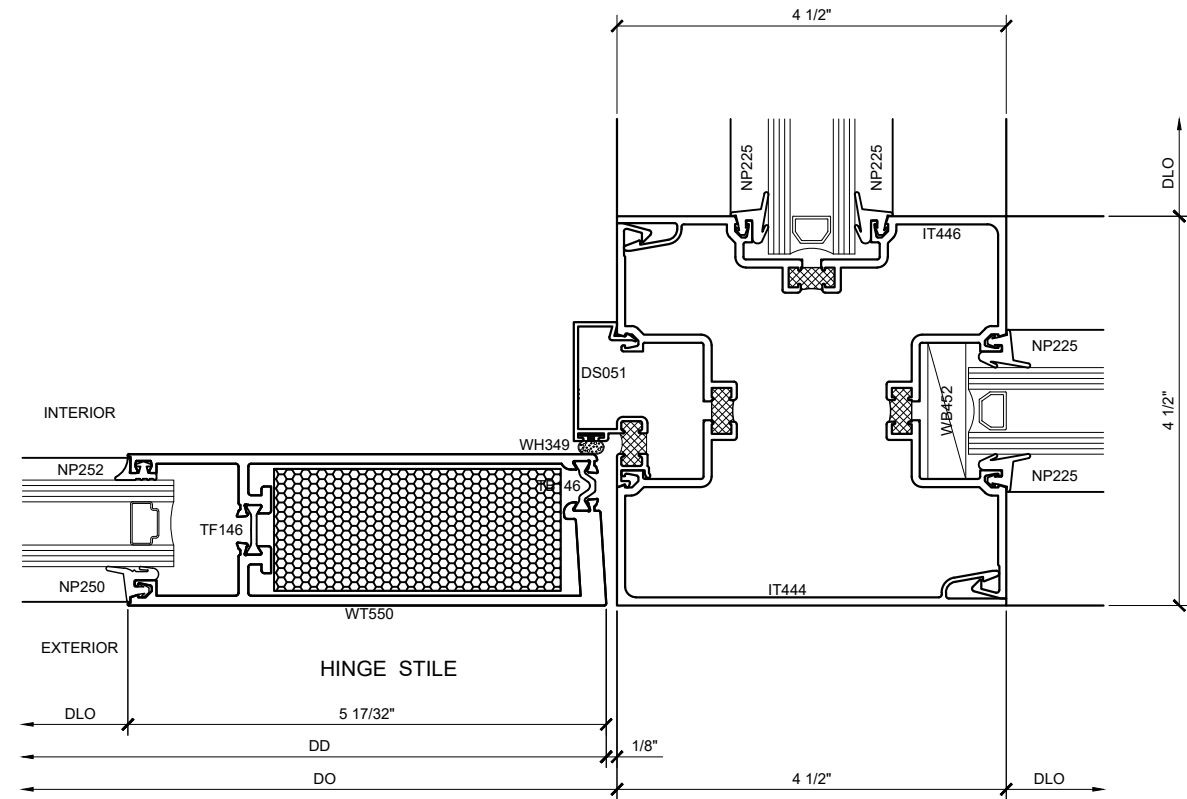

SECTION DETAIL AT WIDE HINGE STYLE  
"T" VERTICAL (13)  
SCALE: FULL SIZE

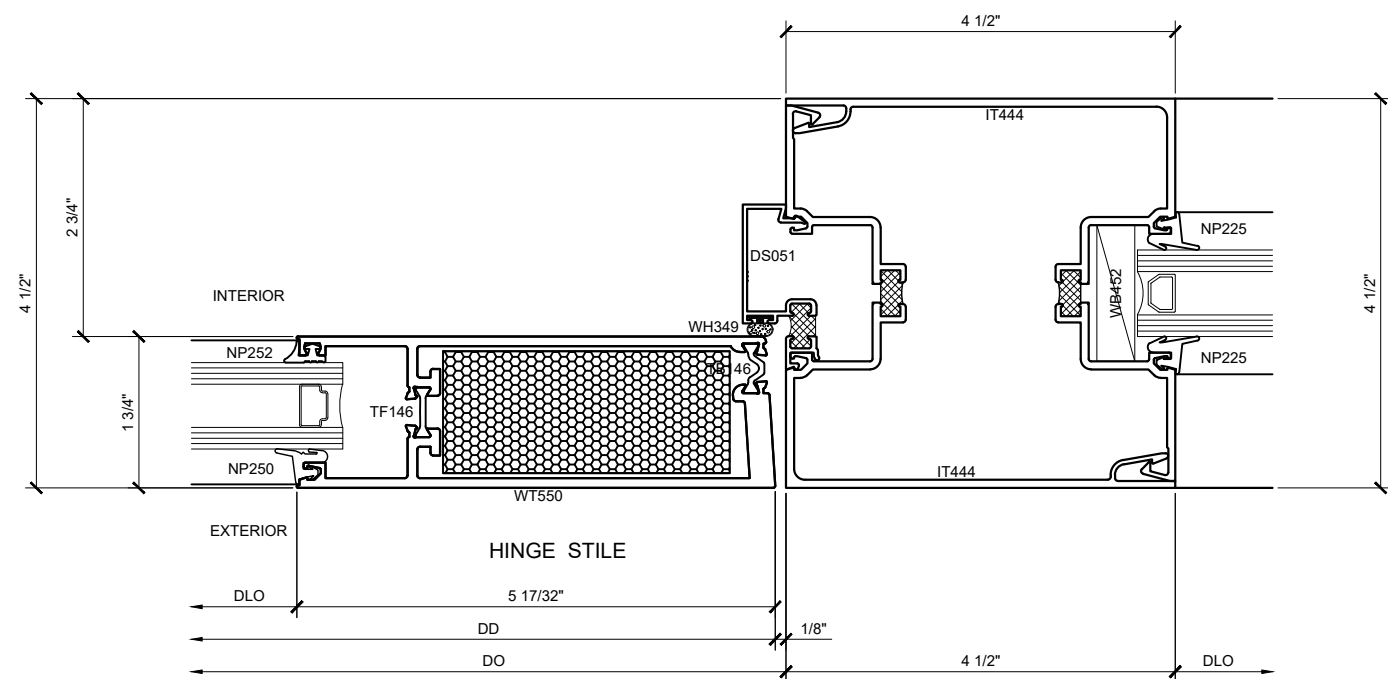

SECTION DETAIL AT WIDE HINGE STYLE  
INTERMEDIATE VERTICAL (14)  
SCALE: FULL SIZE

WIDE STILE OFFSET-HUNG SERIES 550AT DOOR DETAILS  
SHOWN WITH SERIES IT451 STOREFRONT SYSTEM

|               |          |
|---------------|----------|
| Revisions By: |          |
| TMG           | 10/20/17 |

**U.S. ALUMINUM**  
C.R. LAURENCE CO. ARCHITECTURAL PRODUCTS  
2503 E. Vernon Avenue, Los Angeles, CA 90058-1897  
PH: (800) 421-6144 FX: (800) 857-7501 www.crlaurence.com

Description:  
U.S. ALUMINUM  
WIDE STILE SERIES 550AT  
DOOR SYSTEM

|            |           |
|------------|-----------|
| Drawn By:  | RPD       |
| Date:      | 01/17/17  |
| Scale:     | AS NOTED  |
| File Name: | 550AT.dwg |

Sheet

U.S. ALUMINUM WIDE STILE SERIES 550AT DOOR SYSTEM

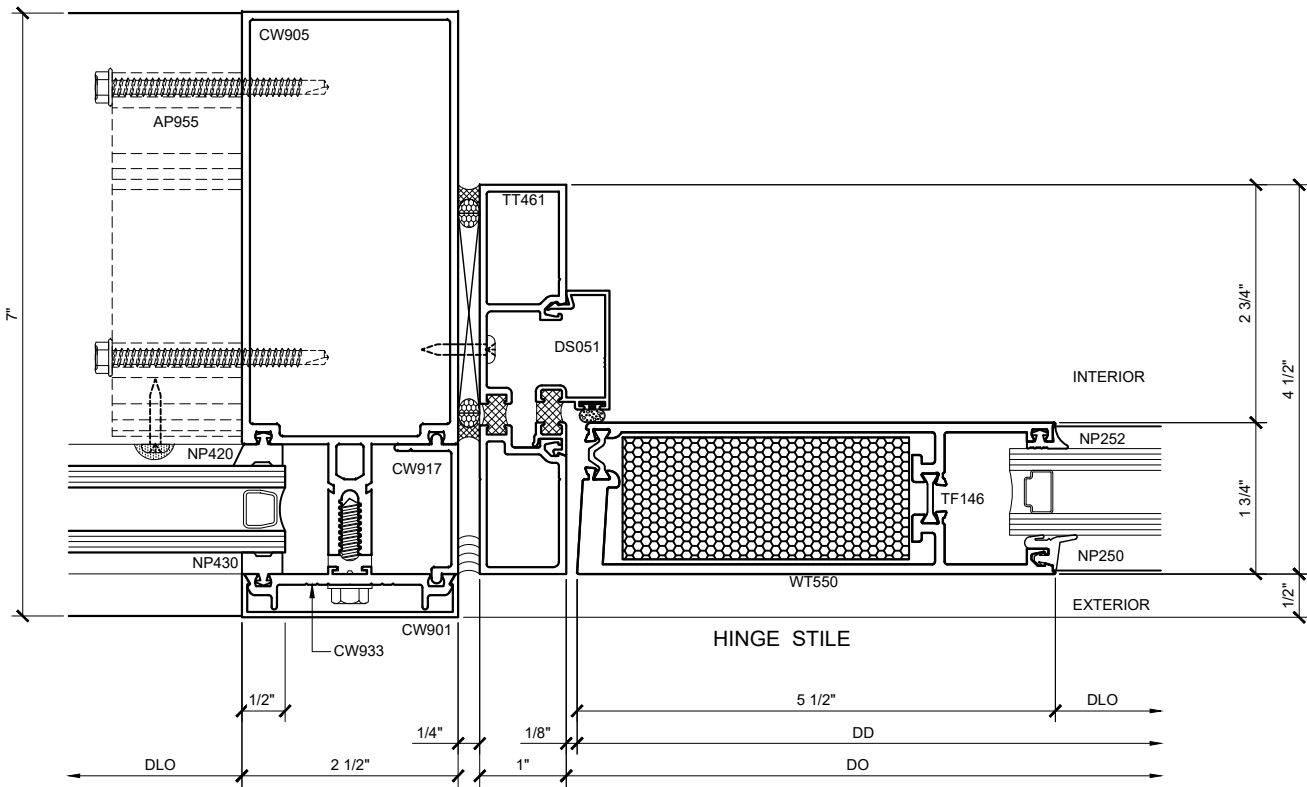

**SECTION DETAIL @ DOOR JAMB** (15)  
 (SHOWN WITH SERIES 3250 CURTAIN WALL SYSTEM) SCALE: FULL SIZE

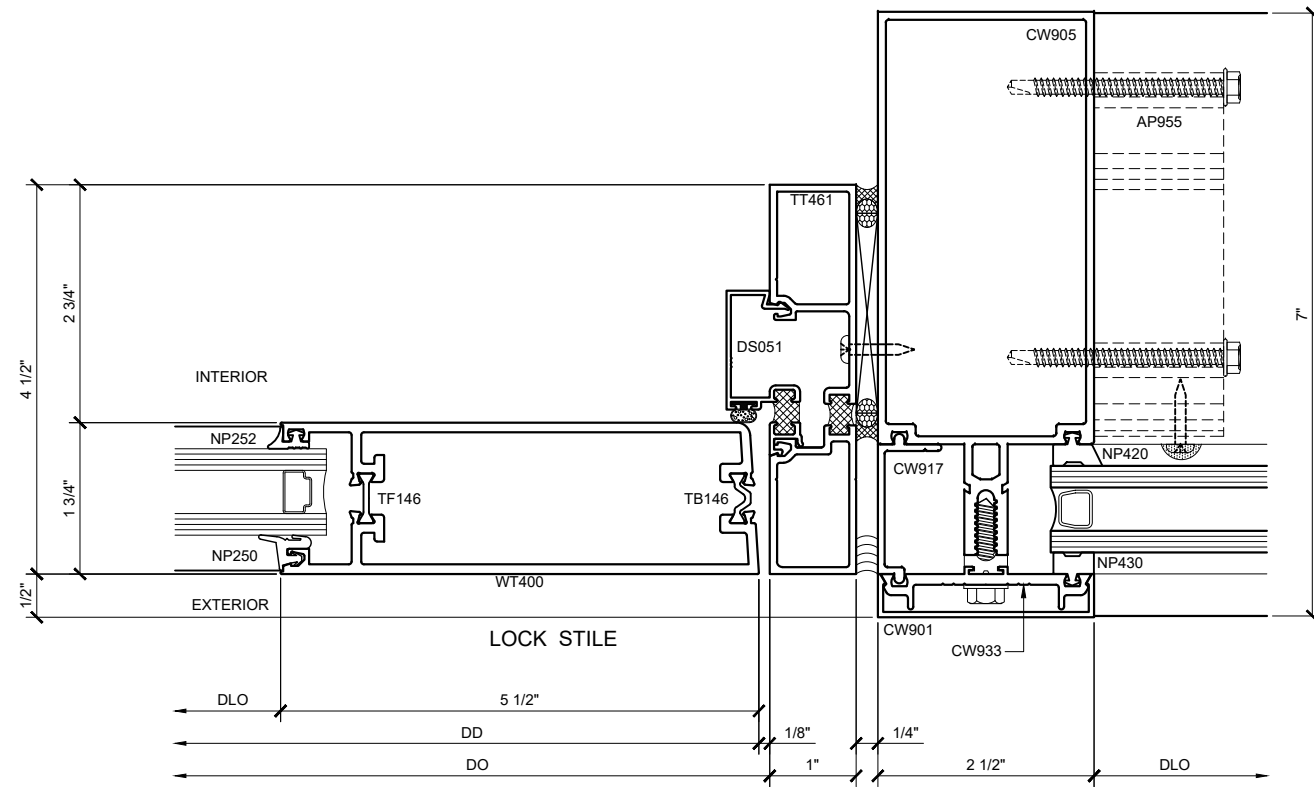

**SECTION DETAIL @ DOOR JAMB** (16)  
 (SHOWN WITH SERIES 3250 CURTAIN WALL SYSTEM) SCALE: FULL SIZE

**WIDE STILE OFFSET-HUNG SERIES 550AT DOOR DETAILS**  
 SHOWN WITH SERIES 3250 CURTAIN WALL SYSTEM

Revisions By:  
 TMG 10/20/17



Description:  
 U.S. ALUMINUM  
 WIDE STILE SERIES 550AT  
 DOOR SYSTEM

Drawn By: RPD  
 Date: 01/17/17  
 Scale: AS NOTED  
 File Name: 550AT.dwg

Sheet

2.05