

U.S. ALUMINUM MEDIUM STILE SERIES 400T DOOR SYSTEM

DOOR SWING CHART

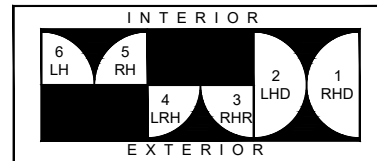

STANDARD ABBREVIATIONS

| | |
|------|---------------------------|
| RO | ROUGH OPENING |
| FD | FRAME DIMENSION |
| DLO | DAYLIGHT OPENING |
| DO | DOOR OPENING |
| DD | DOOR DIMENSION |
| SMC | SURFACE MOUNTED CLOSER |
| OHCC | OVERHEAD CONCEALED CLOSER |

STRUCTURAL DISCLAIMER:

ALL CUSTOMERS WHO IN ANY WAY UTILIZE THIS PRODUCT ARE SOLELY RESPONSIBLE TO CONSULT A STRUCTURAL ENGINEER TO DETERMINE THE SUITABILITY OF THE PRODUCT FOR THE INTENDED USE AND SITE CONDITIONS. ALL INSTALLERS MUST BE QUALIFIED AND HAVE PROFESSIONAL KNOWLEDGE ABOUT COMPLIANCE WITH LOCAL, STATE AND FEDERAL REGULATIONS, SAFETY FACTORS, AND THE APPROPRIATE CHOICE OF FIXING MATERIAL AND PROCEDURES.

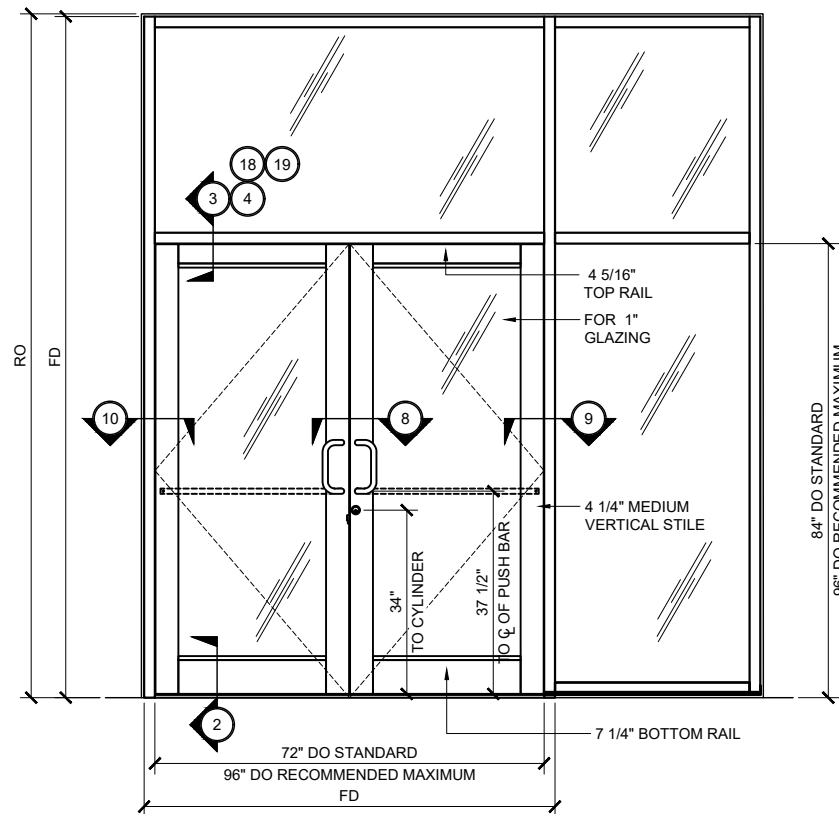

MEDIUM STILE SERIES 400T DOOR TYP. ELEVATION
(DOUBLE DOOR @ TRANSOM FRAME) 3/4" = 1'-0"

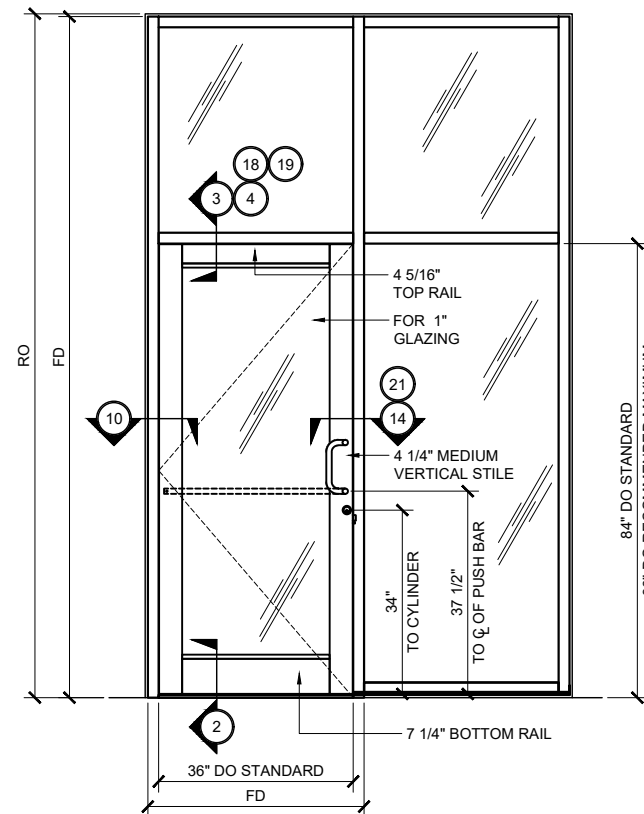

MEDIUM STILE SERIES 400T DOOR TYP. ELEVATION
(SINGLE DOOR @ TRANSOM FRAME) 3/4" = 1'-0"

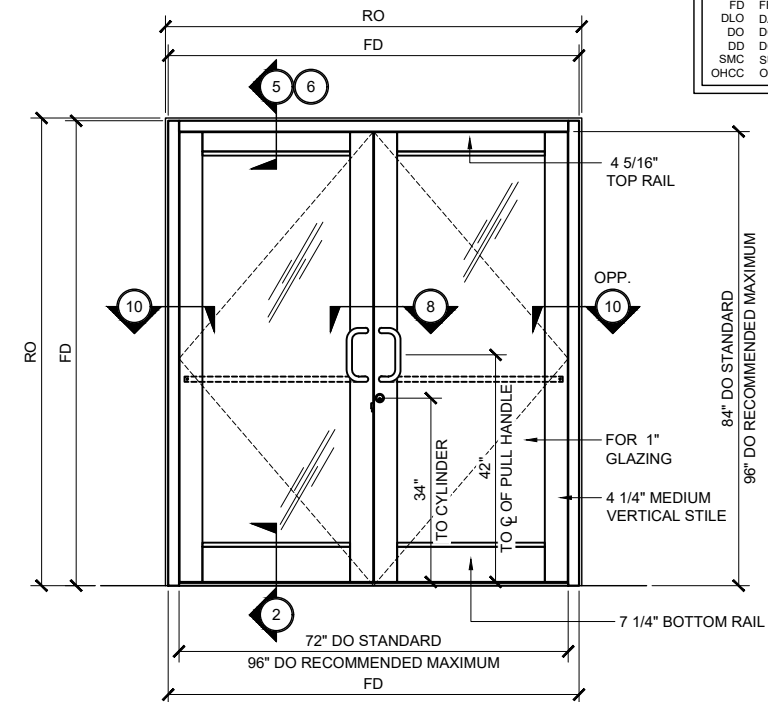

MEDIUM STILE SERIES 400T DOOR TYP. ELEVATION
(DOUBLE DOOR @ UP / OVER FRAME) 3/4" = 1'-0"

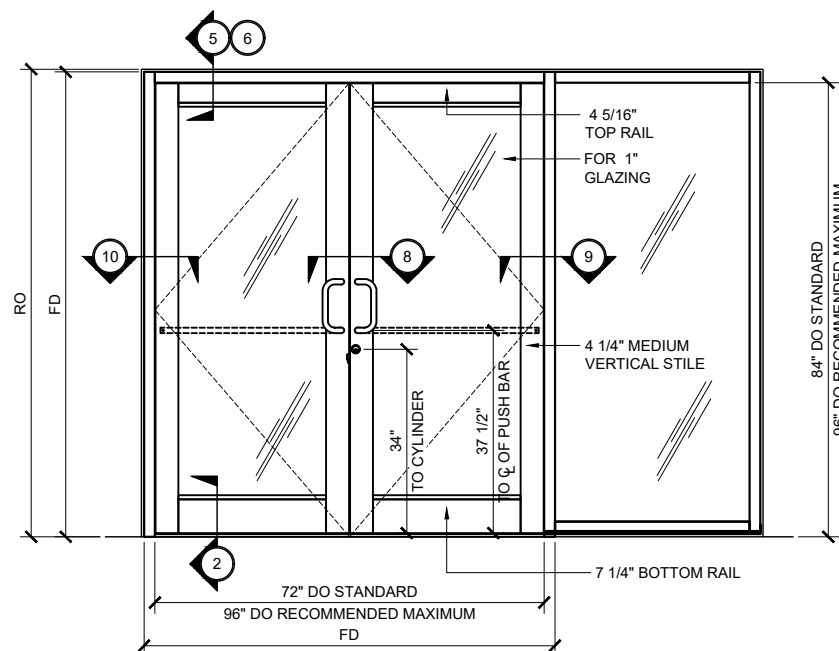

MEDIUM STILE SERIES 400T DOOR TYP. ELEVATION
(DOUBLE DOOR @ UP / OVER FRAME WITH SIDELITE) 3/4" = 1'-0"

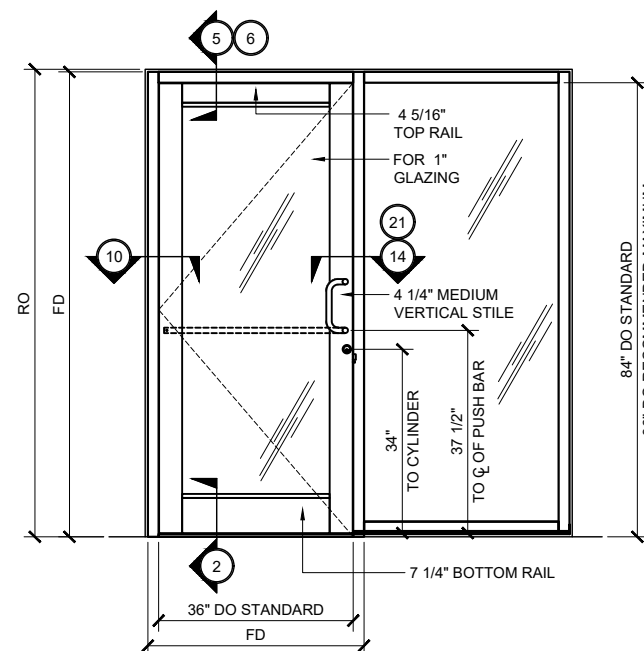

MEDIUM STILE SERIES 400T DOOR TYP. ELEVATION
(SINGLE DOOR @ UP / OVER FRAME WITH SIDELITE) 3/4" = 1'-0"

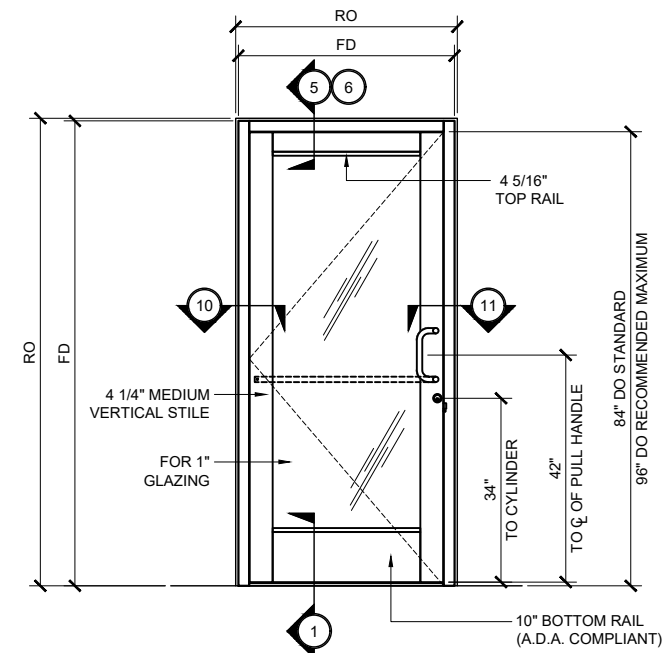

MEDIUM STILE SERIES 400T DOOR TYP. ELEVATION
(SINGLE DOOR @ UP / OVER FRAME) (SHOWN W/ 10" BOTTOM RAIL) 3/4" = 1'-0"

Revisions By:

| | |
|-----|----------|
| TMG | 10/20/17 |
| TMG | 05/05/18 |

U.S. ALUMINUM
C.R. LAURENCE CO. ARCHITECTURAL PRODUCTS
2503 E. Vernon Avenue, Los Angeles, CA 90058-1897
PH: (800) 421-6144 FX: (800) 857-7501 www.crlaurence.com

Description:
U.S. ALUMINUM
MEDIUM STILE SERIES 400T
DOOR SYSTEM

Drawn By: RPD
Date: 01/17/17
Scale: AS NOTED
File Name: 400T.dwg

Sheet

U.S. ALUMINUM MEDIUM STILE SERIES 400T DOOR SYSTEM

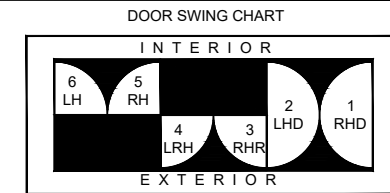

STANDARD ABBREVIATIONS

| | |
|------|---------------------------|
| RO | ROUGH OPENING |
| FD | FRAME DIMENSION |
| DLO | DAYLIGHT OPENING |
| DO | DOOR OPENING |
| DD | DOOR DIMENSION |
| SMC | SURFACE MOUNTED CLOSER |
| OHCC | OVERHEAD CONCEALED CLOSER |

Revisions By:

| | |
|-----|----------|
| TMG | 10/20/17 |
| TMG | 05/05/18 |

U.S. ALUMINUM
 C.R. LAURENCE CO. ARCHITECTURAL PRODUCTS
 2503 E. Vernon Avenue, Los Angeles, CA 90058-1897
 PH: (800) 421-1144 FX: (800) 857-7501 www.crlaurence.com

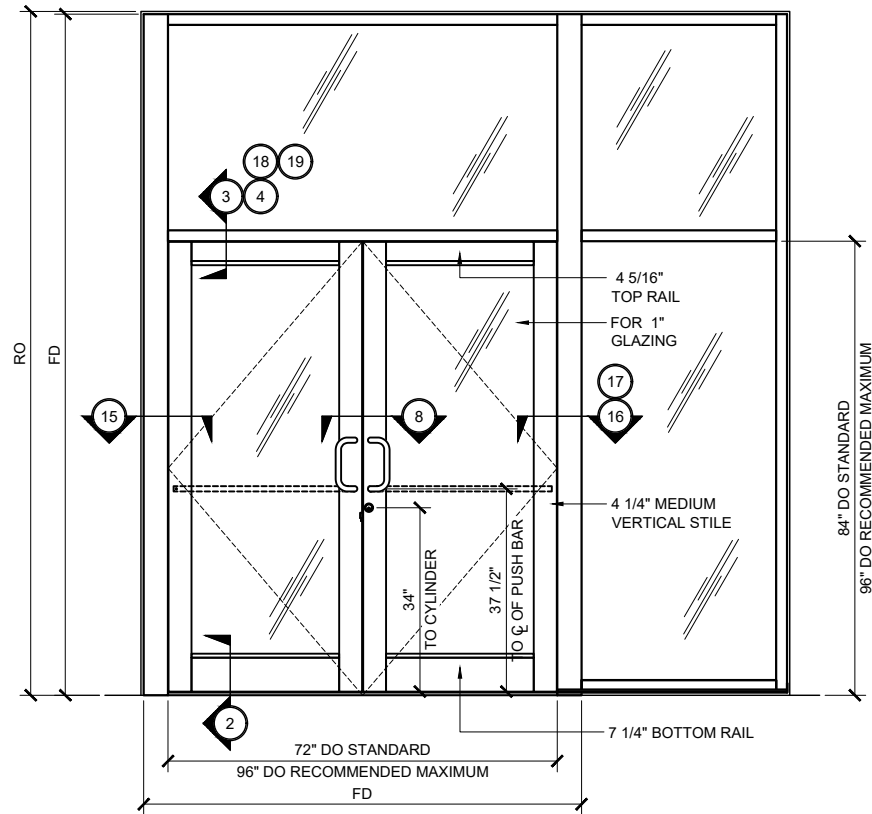

MEDIUM STILE SERIES 400T DOOR TYP. ELEVATION
 (DOUBLE DOOR @ TRANSOM FRAME) 3/4" = 1'-0"

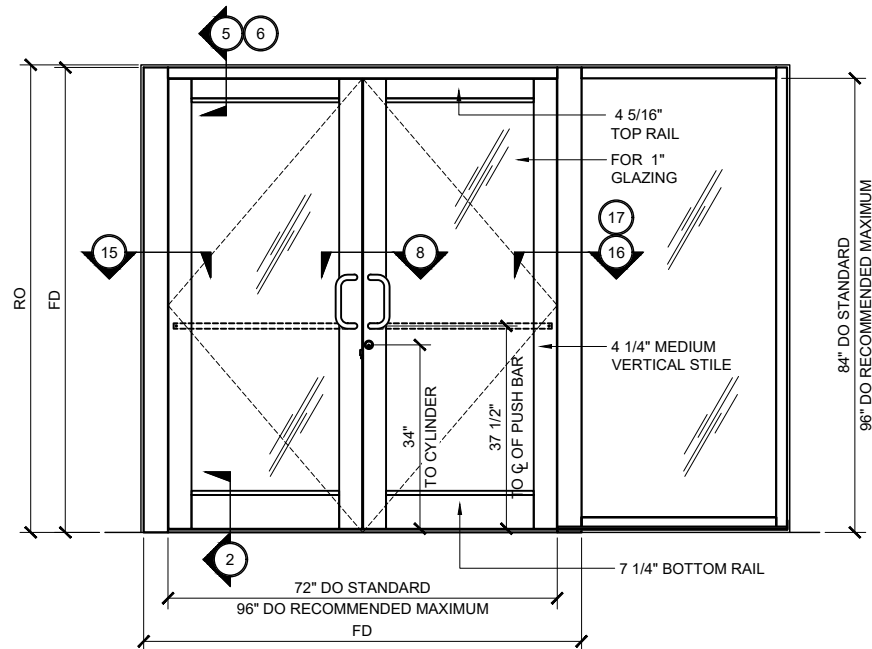

MEDIUM STILE SERIES 400T DOOR TYP. ELEVATION
 (DOUBLE DOOR @ UP / OVER FRAME WITH SIDELITE) 3/4" = 1'-0"

Description:
 U.S. ALUMINUM
 MEDIUM STILE SERIES 400T
 DOOR SYSTEM

Drawn By: RPD
 Date: 01/17/17
 Scale: AS NOTED
 File Name: 400T.dwg

Sheet

U.S. ALUMINUM MEDIUM STILE SERIES 400T DOOR SYSTEM

Revisions By:

TMG 10/20/17
 TMG 05/05/18

U.S. ALUMINUM
 C.R. LAURENCE CO. ARCHITECTURAL PRODUCTS
 2503 E. Vernon Avenue, Los Angeles, CA 90058-1897
 PH: (800) 421-6144 FX: (800) 857-7501 www.crlaurence.com

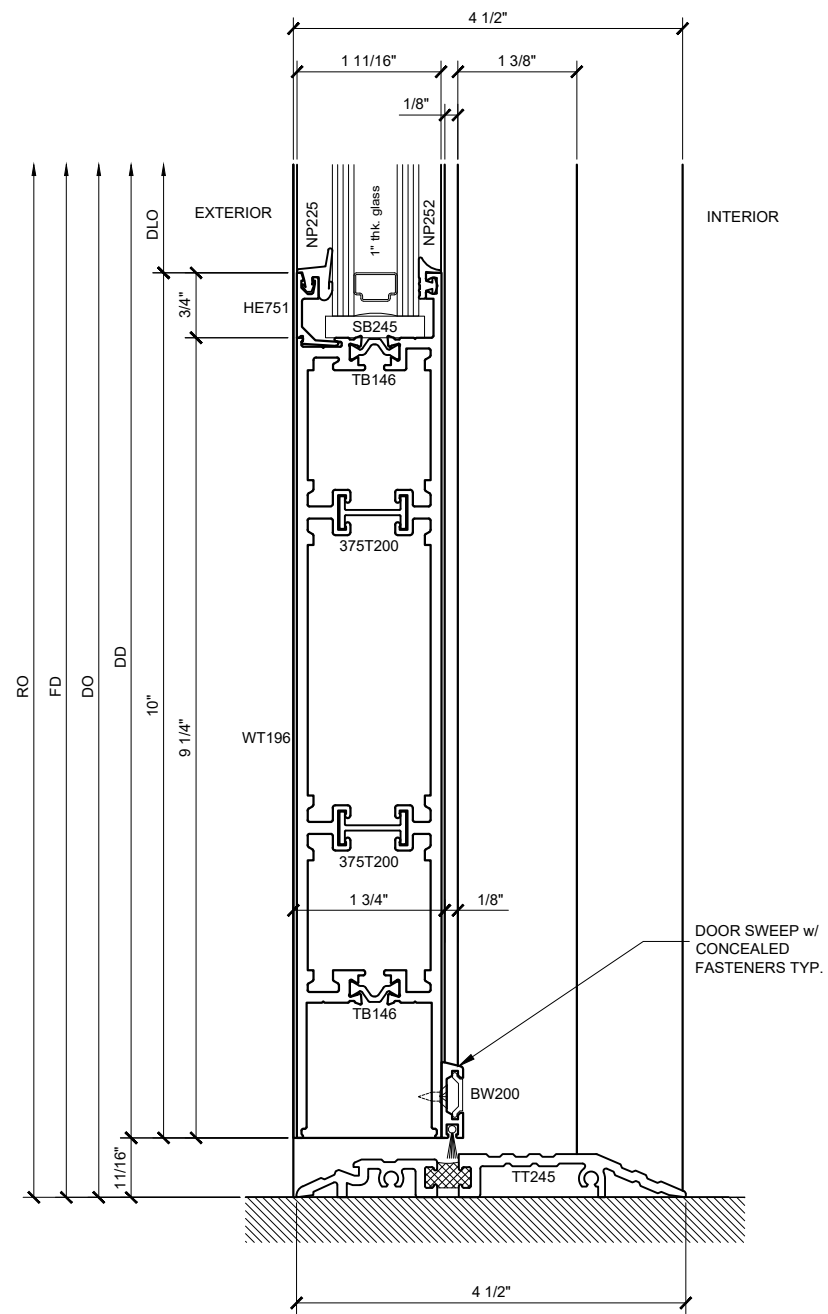

SECTION DETAIL @ 10" DOOR SILL ①

SCALE: FULL SIZE

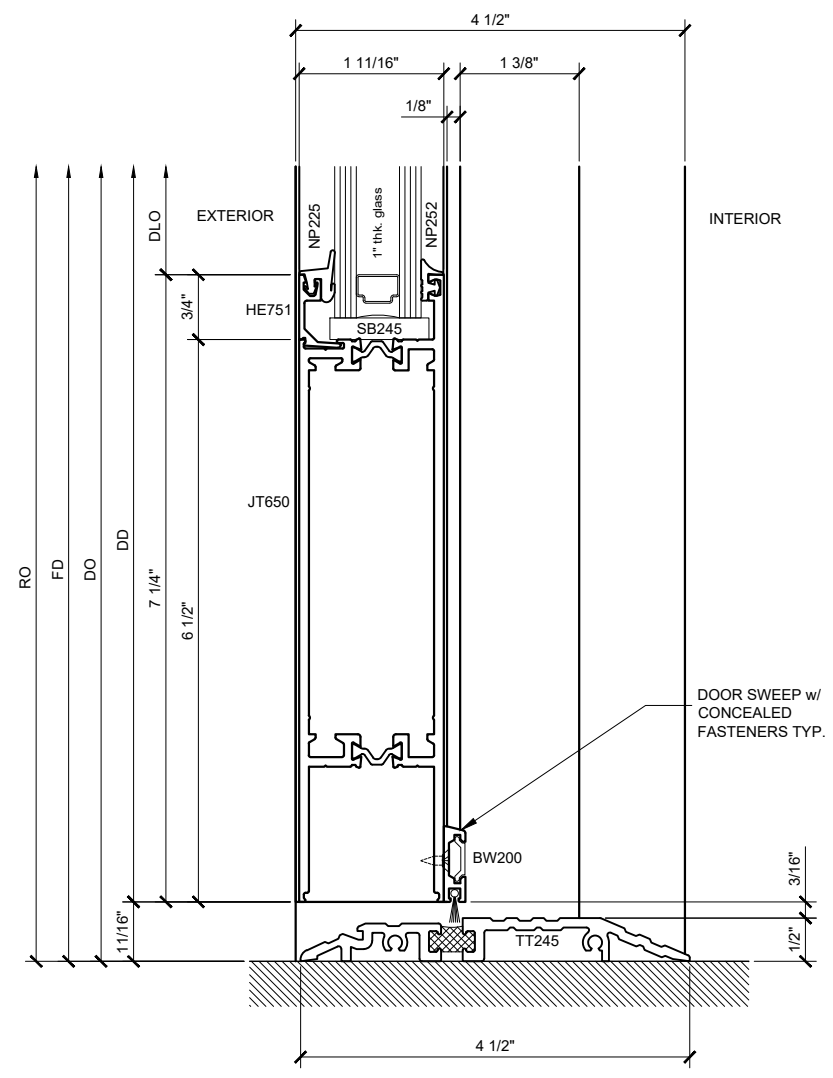

SECTION DETAIL @ 7 1/4" DOOR SILL ②

SCALE: FULL SIZE

Description:
 U.S. ALUMINUM
 MEDIUM STILE SERIES 400T
 DOOR SYSTEM

Drawn By: RPD
 Date: 01/17/17
 Scale: AS NOTED
 File Name: 400T.dwg

Sheet

1.01

MEDIUM STILE OFFSET-HUNG SERIES 400T DOOR DETAILS
 SHOWN WITH SERIES IT451 STOREFRONT SYSTEM

U.S. ALUMINUM MEDIUM STILE SERIES 400T DOOR SYSTEM

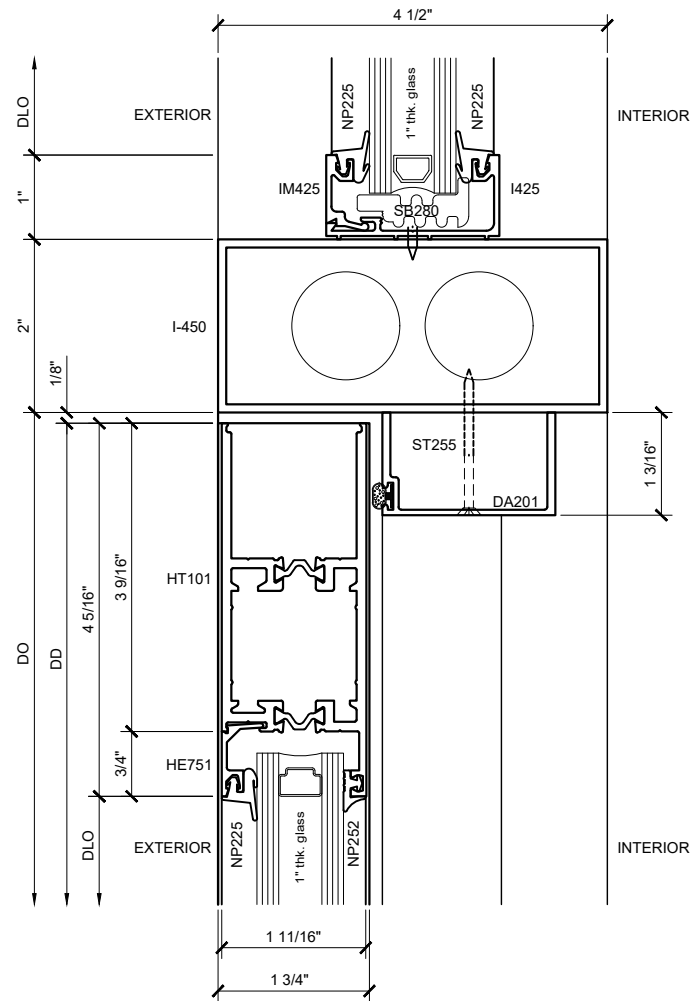

SECTION DETAIL @ DOOR HEAD w/ OHCC ③
SCALE: FULL SIZE

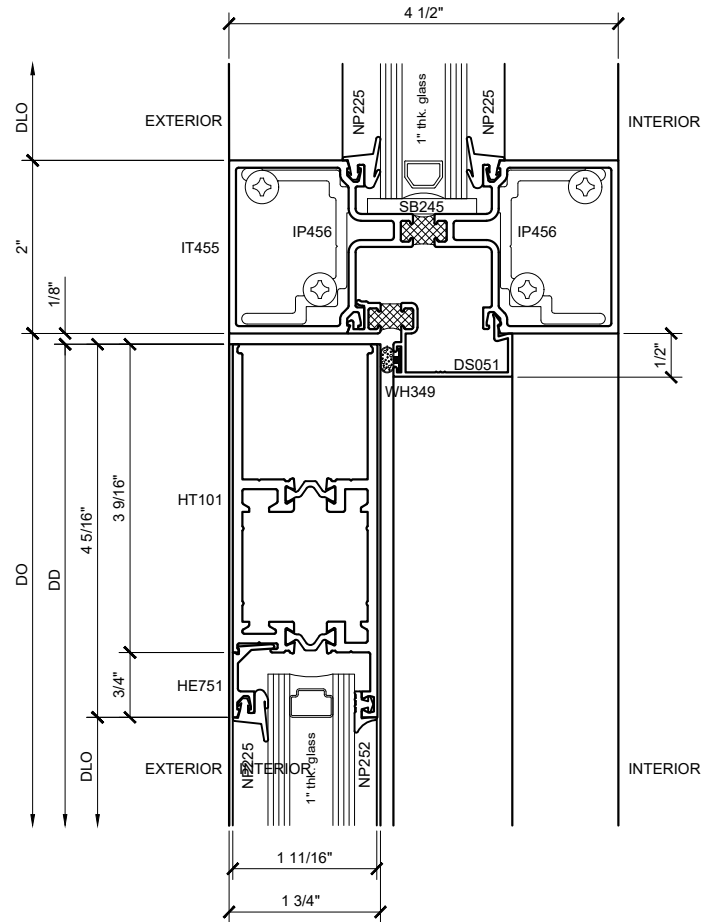

SECTION DETAIL @ DOOR HEAD ④
SCALE: FULL SIZE

MEDIUM STILE OFFSET-HUNG SERIES 400T DOOR DETAILS
SHOWN WITH SERIES IT451 STOREFRONT SYSTEM

| | |
|---------------|----------|
| Revisions By: | |
| TMG | 10/20/17 |
| TMG | 05/05/18 |

U.S. ALUMINUM
C.R. LAURENCE CO. ARCHITECTURAL PRODUCTS
2503 E. Vernon Avenue, Los Angeles, CA 90058-1897
PH: (800) 421-6144 FX: 800-857-7501 www.crlaurence.com

Description:
U.S. ALUMINUM
MEDIUM STILE SERIES 400T
DOOR SYSTEM

| | |
|------------|----------|
| Drawn By: | RPD |
| Date: | 01/17/17 |
| Scale: | AS NOTED |
| File Name: | 400T.dwg |

Sheet

1.02

U.S. ALUMINUM MEDIUM STILE SERIES 400T DOOR SYSTEM

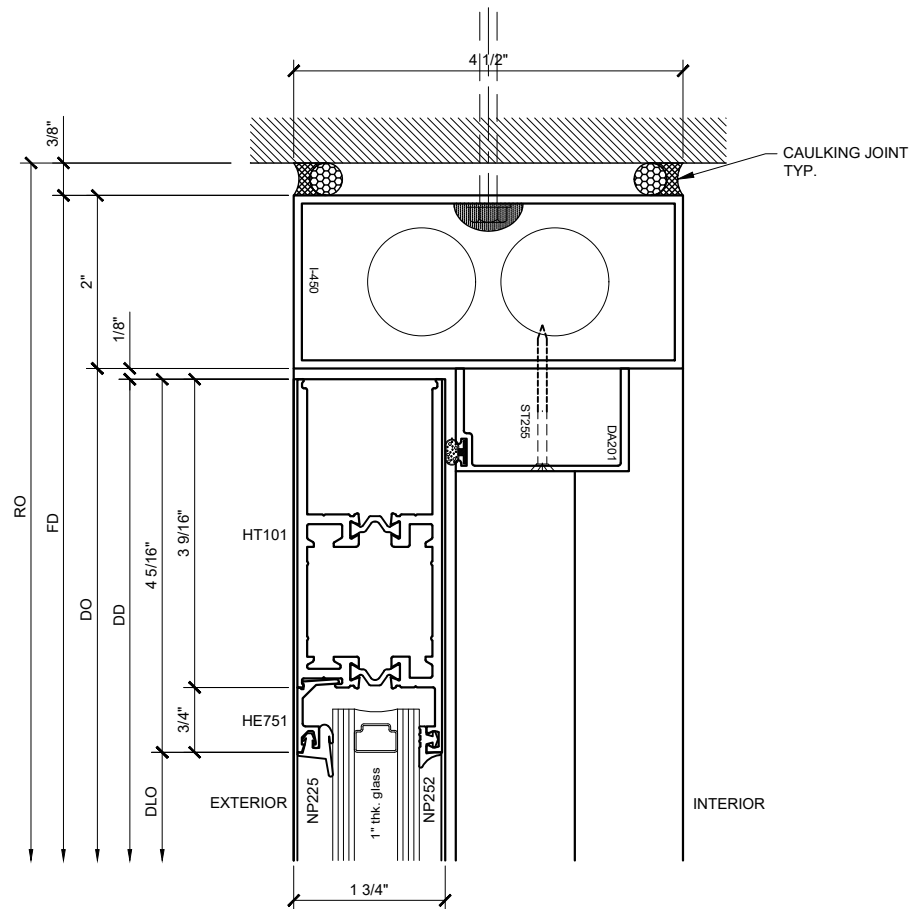

SECTION DETAIL @ DOOR HEAD w/ OHCC (5)
SCALE: FULL SIZE

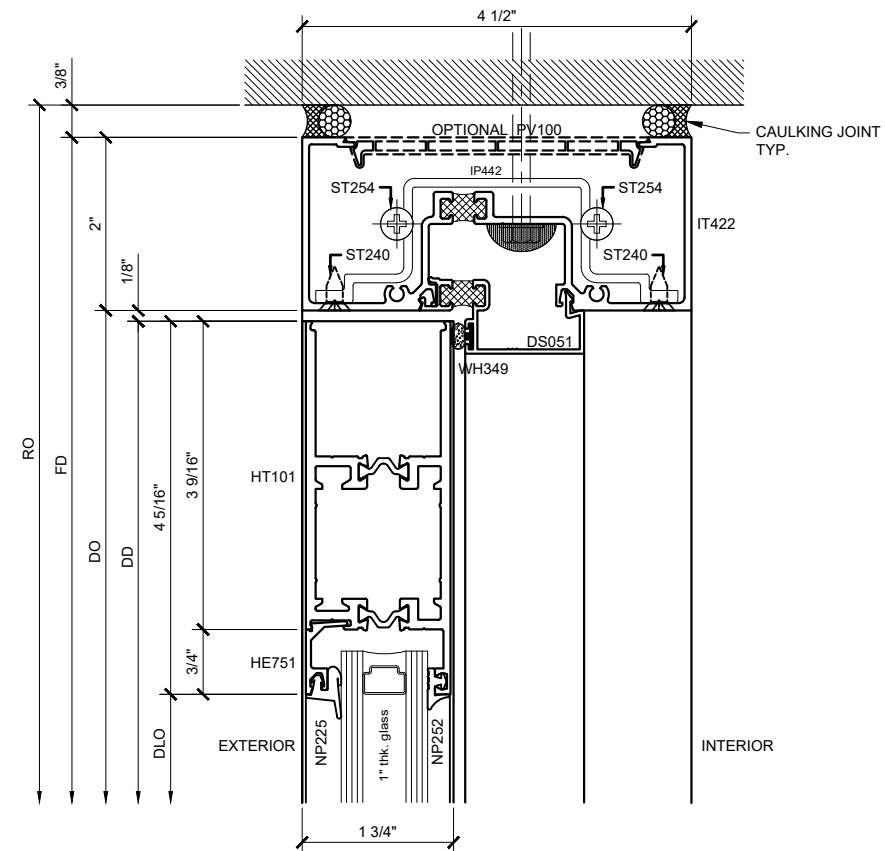

SECTION DETAIL @ DOOR HEAD (6)
SCALE: FULL SIZE

MEDIUM STILE OFFSET-HUNG SERIES 400T DOOR DETAILS
SHOWN WITH SERIES IT451 STOREFRONT SYSTEM

| | |
|---------------|----------|
| Revisions By: | |
| TMG | 10/20/17 |
| TMG | 05/05/18 |

CAL
ALUMINUM
C.R. LAURENCE CO. ARCHITECTURAL PRODUCTS
2503 E. Vernon Avenue, Los Angeles, CA 90058-1897
PH: (800) 421-6144 FX: 800-857-7501 www.crlaurence.com

Description:
U.S. ALUMINUM
MEDIUM STILE SERIES 400T
DOOR SYSTEM

| | |
|------------|----------|
| Drawn By: | RPD |
| Date: | 01/17/17 |
| Scale: | AS NOTED |
| File Name: | 400T.dwg |

Sheet

1.03

U.S. ALUMINUM MEDIUM STILE SERIES 400T DOOR SYSTEM

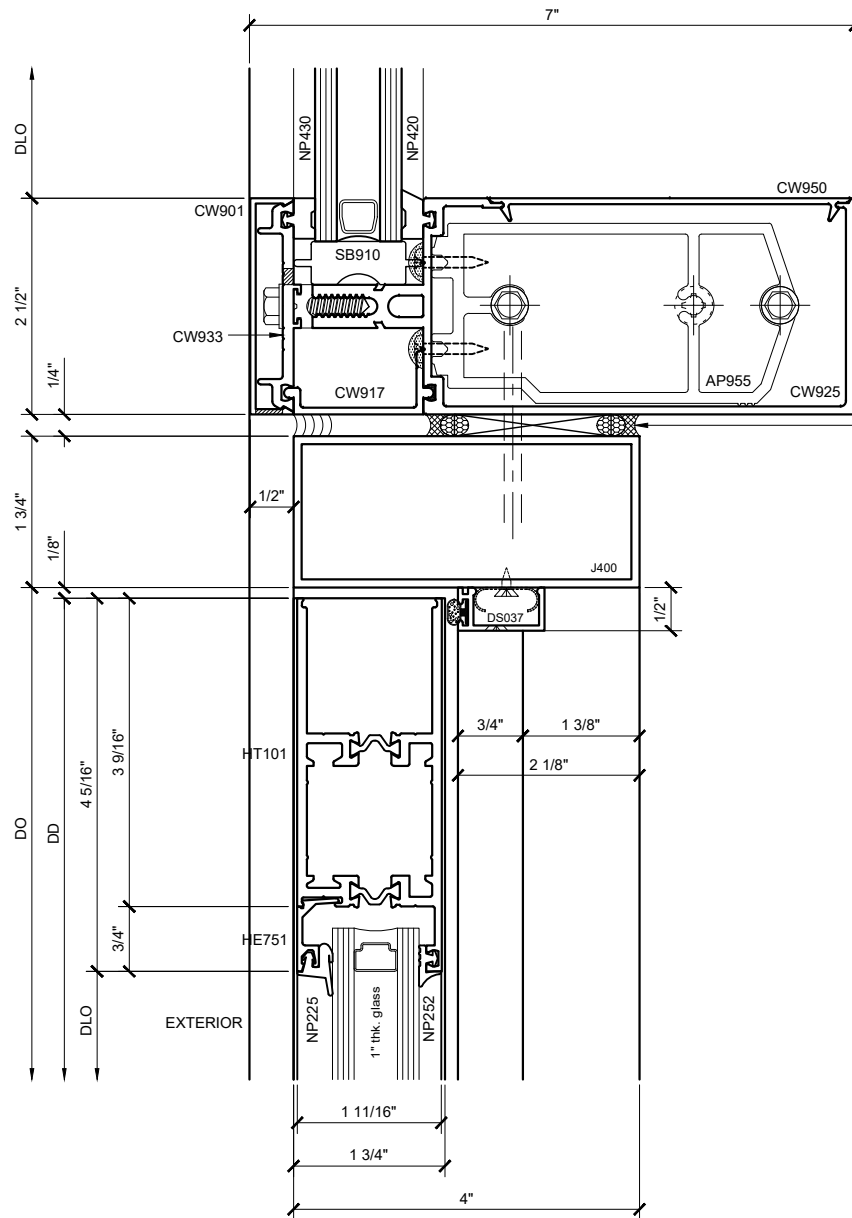

SECTION DETAIL @ DOOR HEAD w/ OHCC ¹⁸
SCALE: FULL SIZE

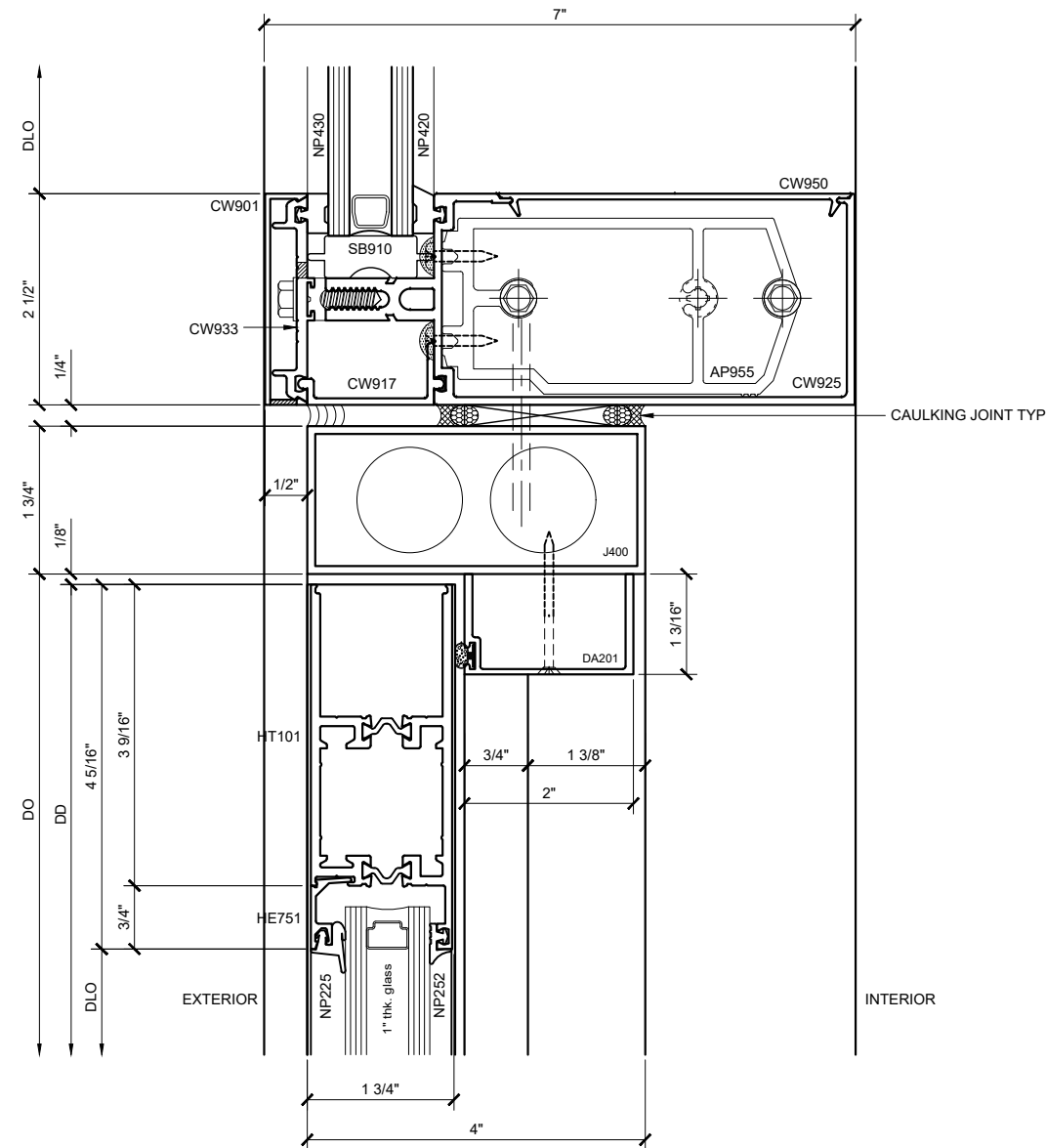

SECTION DETAIL @ DOOR HEAD w/ OHCC ¹⁹
SCALE: FULL SIZE

MEDIUM STILE OFFSET-HUNG SERIES 400T DOOR DETAILS
SHOWN WITH SERIES 3250 STOREFRONT SYSTEM

| | |
|---------------|----------|
| Revisions By: | |
| TMG | 10/20/17 |
| TMG | 05/05/18 |

CAL
ALUMINUM
C.R. LAURENCE CO. ARCHITECTURAL PRODUCTS
2503 E. Vernon Avenue, Los Angeles, CA 90058-1897
PH: (800) 421-6144 FX: (800) 857-7501 www.crlaurence.com

Description:
U.S. ALUMINUM
MEDIUM STILE SERIES 400T
DOOR SYSTEM

| | |
|------------|----------|
| Drawn By: | RPD |
| Date: | 01/17/17 |
| Scale: | AS NOTED |
| File Name: | 400T.dwg |

Sheet

1.04

U.S. ALUMINUM MEDIUM STILE SERIES 400T DOOR SYSTEM

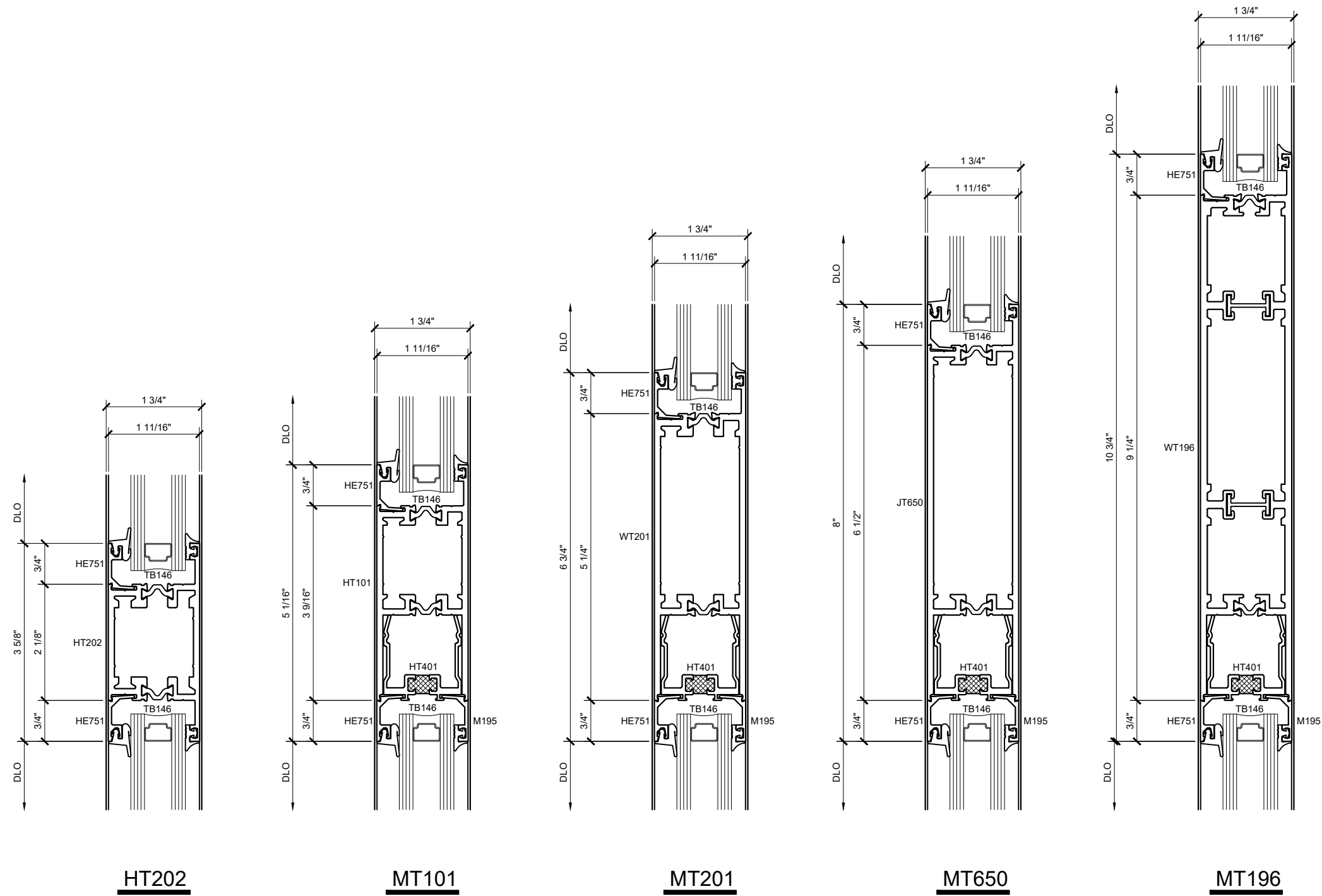

| | |
|---------------|----------|
| Revisions By: | |
| TMG | 10/20/17 |
| TMG | 05/05/18 |

CAL
ALUMINUM
 C.R. LAURENCE CO. ARCHITECTURAL PRODUCTS
 2503 E. Vernon Avenue, Los Angeles, CA 90058-1897
 PH: (800) 421-6144 FX: 800-857-7501 www.crlaurence.com

Description:
 U.S. ALUMINUM
 MEDIUM STILE SERIES 400T
 DOOR SYSTEM

| | |
|------------|----------|
| Drawn By: | RPD |
| Date: | 01/17/17 |
| Scale: | AS NOTED |
| File Name: | 400T.dwg |

Sheet

1.05

NARROW STILE OFFSET-HUNG SERIES 400T DOOR MUNTINS

U.S. ALUMINUM MEDIUM STILE SERIES 400T DOOR SYSTEM

Revisions By:

TMG 10/20/17
 TMG 05/05/18

CAL
ALUMINUM
 C.R. LAURENCE CO. ARCHITECTURAL PRODUCTS
 2503 E. Vernon Avenue, Los Angeles, CA 90058-1897
 PH: (800) 421-6144 FX: 800-857-7501 www.crlaurence.com

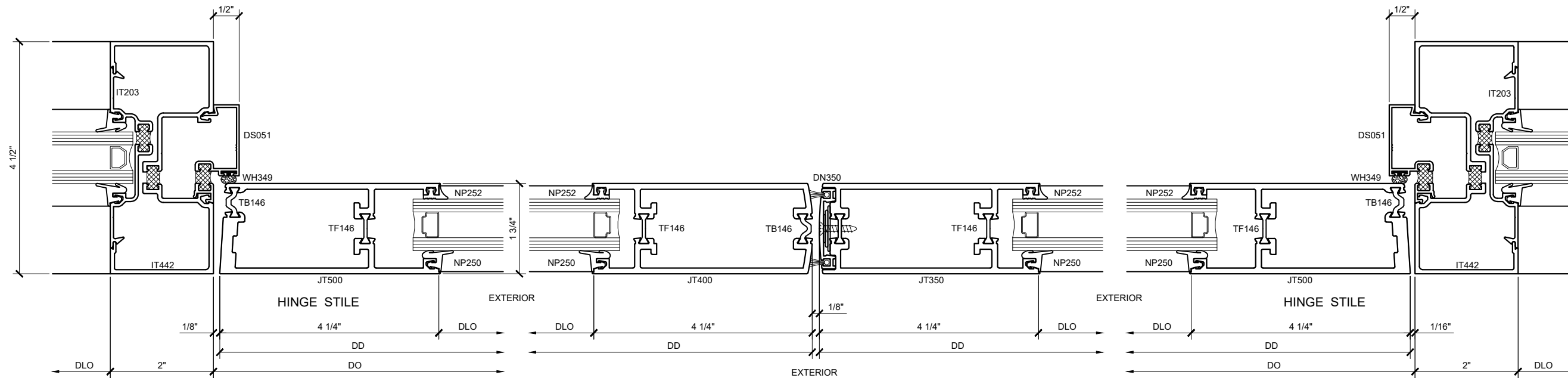

SECTION DETAIL @ DOOR JAMB ⑦
 SCALE: FULL SIZE

SECTION DETAIL @ MEETING STILES ⑧
 SCALE: FULL SIZE

SECTION DETAIL @ DOOR JAMB ⑨
 SCALE: FULL SIZE

Description:
 U.S. ALUMINUM
 MEDIUM STILE SERIES 400T
 DOOR SYSTEM

Drawn By: RPD
 Date: 01/17/17
 Scale: AS NOTED
 File Name: 400T.dwg

Sheet

MEDIUM STILE OFFSET-HUNG SERIES 400T DOOR DETAILS
 SHOWN WITH SERIES IT451 STOREFRONT SYSTEM

U.S. ALUMINUM MEDIUM STILE SERIES 400T DOOR SYSTEM

Revisions By:

TMG 10/20/17

TMG 05/05/18

CAL
ALUMINUM
 C.R. LAURENCE CO. ARCHITECTURAL PRODUCTS
 2503 E. Vernon Avenue, Los Angeles, CA 90058-1897
 PH: (800) 421-6144 FX: 800-857-7501 www.crlaurence.com

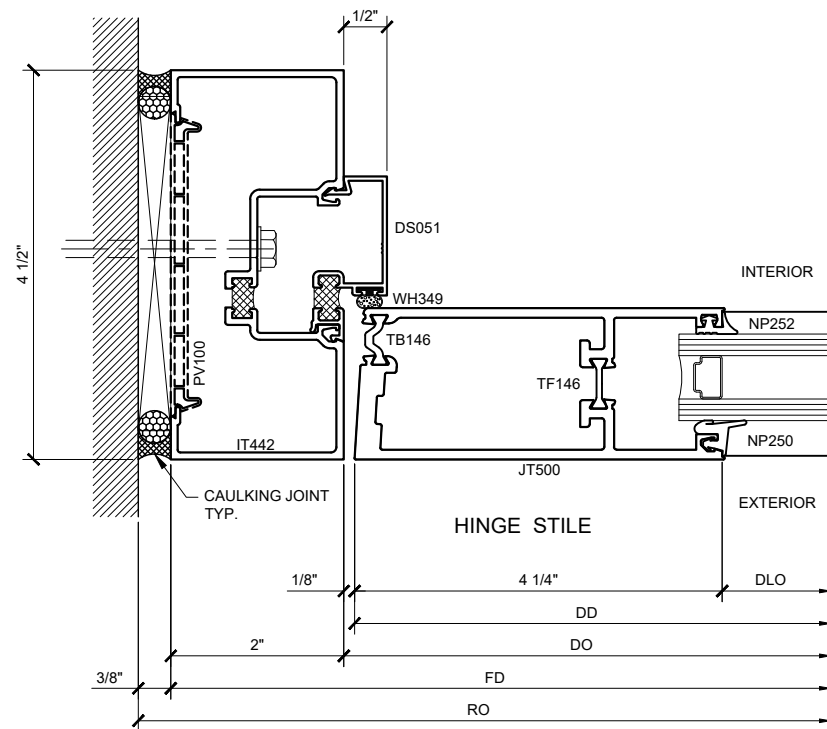

SECTION DETAIL @ DOOR JAMB 10

SCALE: FULL SIZE

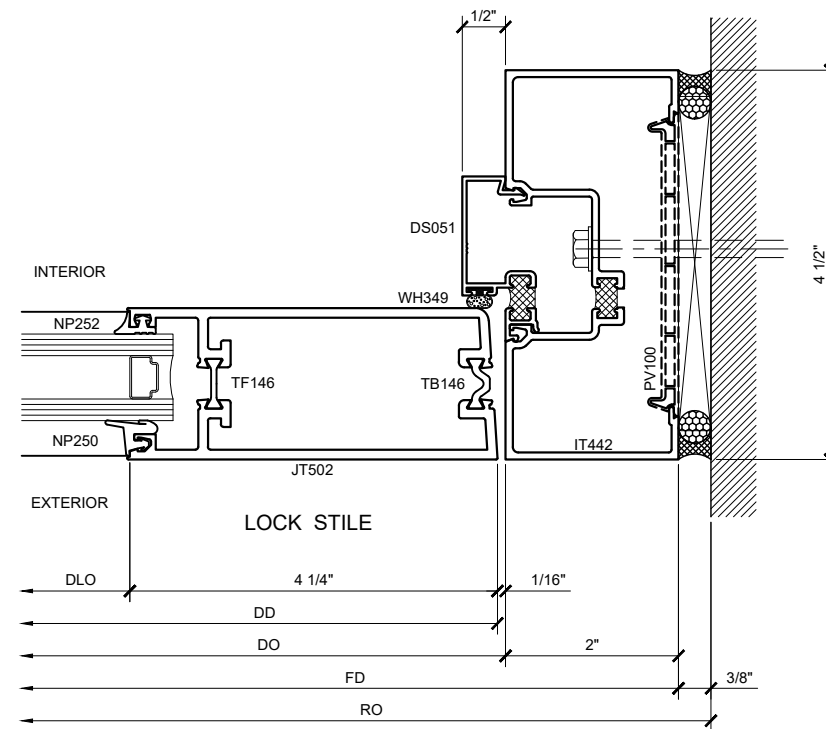

SECTION DETAIL @ DOOR JAMB 11

SCALE: FULL SIZE

Description:
 U.S. ALUMINUM
 MEDIUM STILE SERIES 400T
 DOOR SYSTEM

Drawn By: RPD

Date: 01/17/17

Scale: AS NOTED

File Name: 400T.dwg

Sheet

2.02

MEDIUM STILE OFFSET-HUNG SERIES 400T DOOR DETAILS
 SHOWN WITH SERIES IT451 STOREFRONT SYSTEM

U.S. ALUMINUM MEDIUM STILE SERIES 400T DOOR SYSTEM

Revisions By:

TMG 10/20/17

TMG 05/05/18

CAL
ALUMINUM
 C.R. LAURENCE CO. ARCHITECTURAL PRODUCTS
 2503 E. Vernon Avenue, Los Angeles, CA 90058-1897
 PH: (800) 421-6144 FX: 800-857-7501 www.crlaurence.com

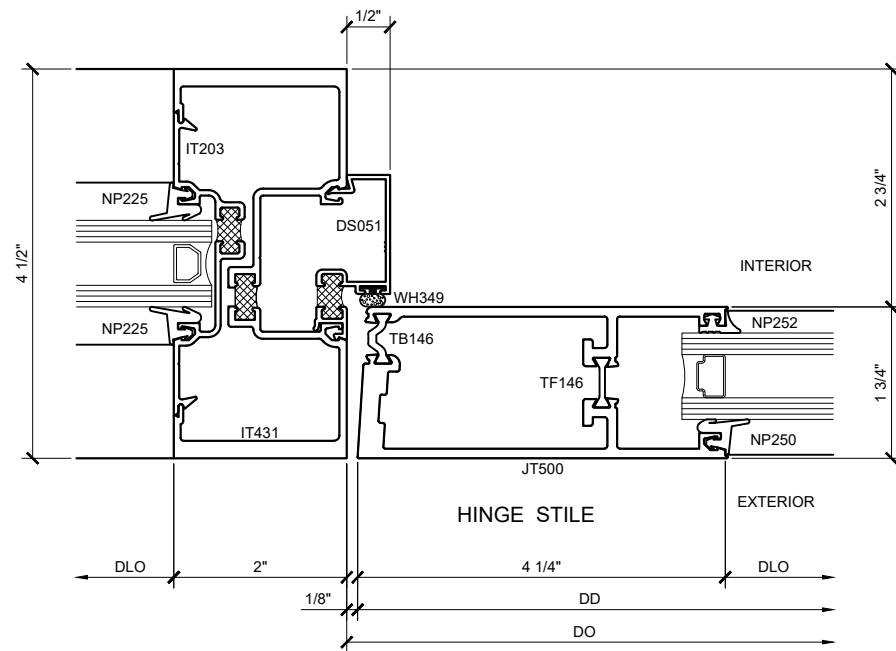

SECTION DETAIL AT
 INTERMEDIATE VERTICAL (12)
 SCALE: FULL SIZE

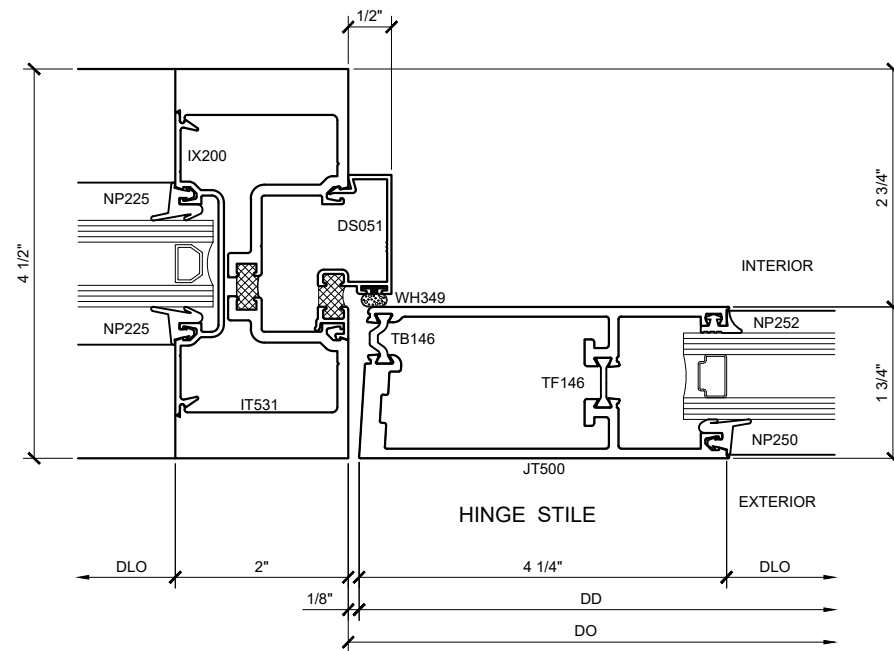

SECTION DETAIL AT
 INTERMEDIATE VERTICAL (13)
 SCALE: FULL SIZE

MEDIUM STILE OFFSET-HUNG SERIES 400T DOOR DETAILS
 SHOWN WITH SERIES IT451 STOREFRONT SYSTEM

Description:
 U.S. ALUMINUM
 MEDIUM STILE SERIES 400T
 DOOR SYSTEM

Drawn By: RPD

Date: 01/17/17

Scale: AS NOTED

File Name: 400T.dwg

Sheet

2.03

U.S. ALUMINUM MEDIUM STILE SERIES 400T DOOR SYSTEM

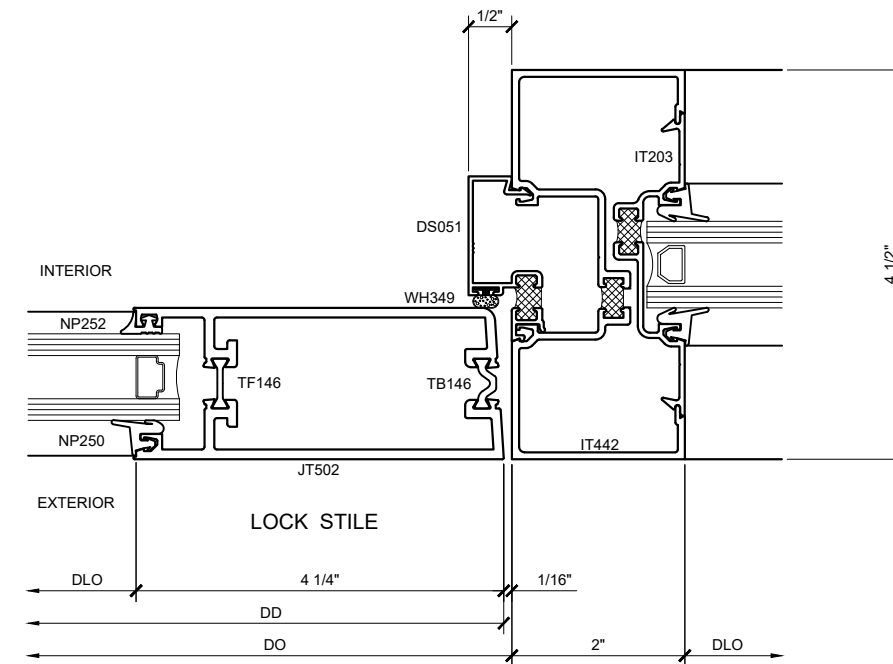

SECTION DETAIL @ DOOR JAMB (14)
SCALE: FULL SIZE

MEDIUM STILE OFFSET-HUNG SERIES 400T DOOR DETAILS
SHOWN WITH SERIES IT451 STOREFRONT SYSTEM

| | |
|---------------|----------|
| Revisions By: | |
| TMG | 10/20/17 |
| TMG | 05/05/18 |

CAL
ALUMINUM
C.R. LAURENCE CO. ARCHITECTURAL PRODUCTS
2503 E. Vernon Avenue, Los Angeles, CA 90058-1897
PH: (800) 421-6144 FX: 800-387-7501 www.crlaurence.com

Description:
U.S. ALUMINUM
MEDIUM STILE SERIES 400T
DOOR SYSTEM

| | |
|------------|----------|
| Drawn By: | RPD |
| Date: | 01/17/17 |
| Scale: | AS NOTED |
| File Name: | 400T.dwg |

Sheet

2.04

U.S. ALUMINUM MEDIUM STILE SERIES 400T DOOR SYSTEM

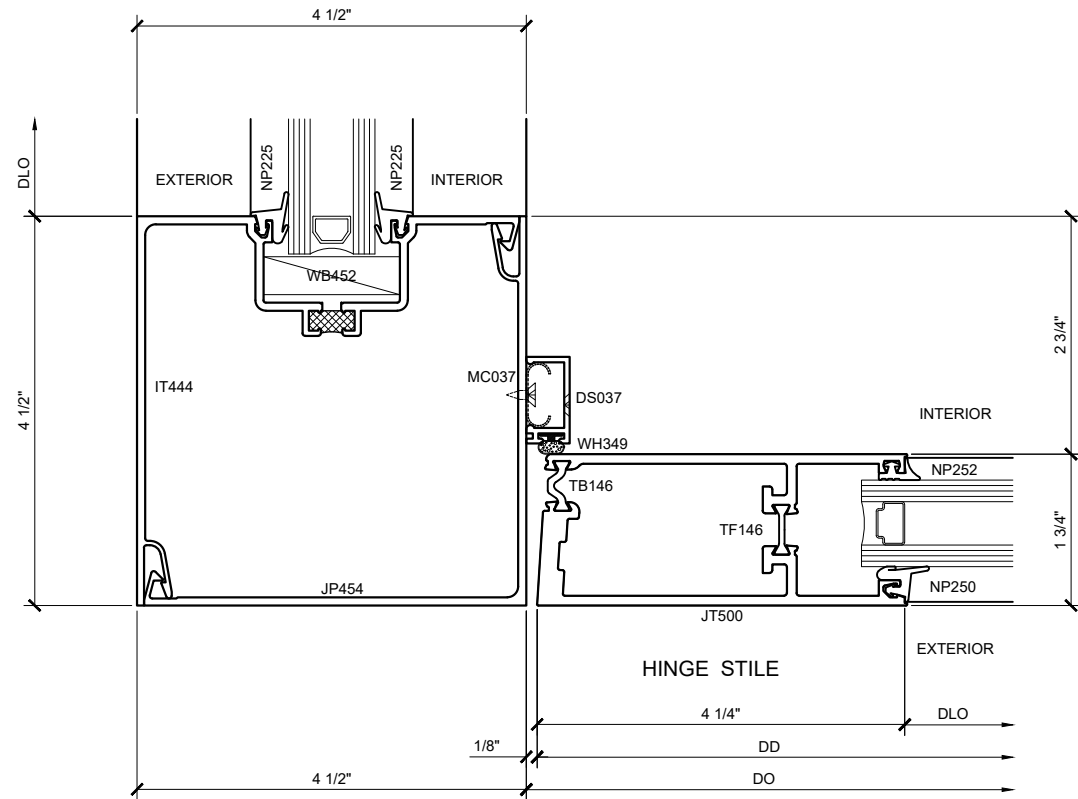

SECTION DETAIL AT WIDE HINGE STYLE
CORNER VERTICAL (15)
SCALE: FULL SIZE

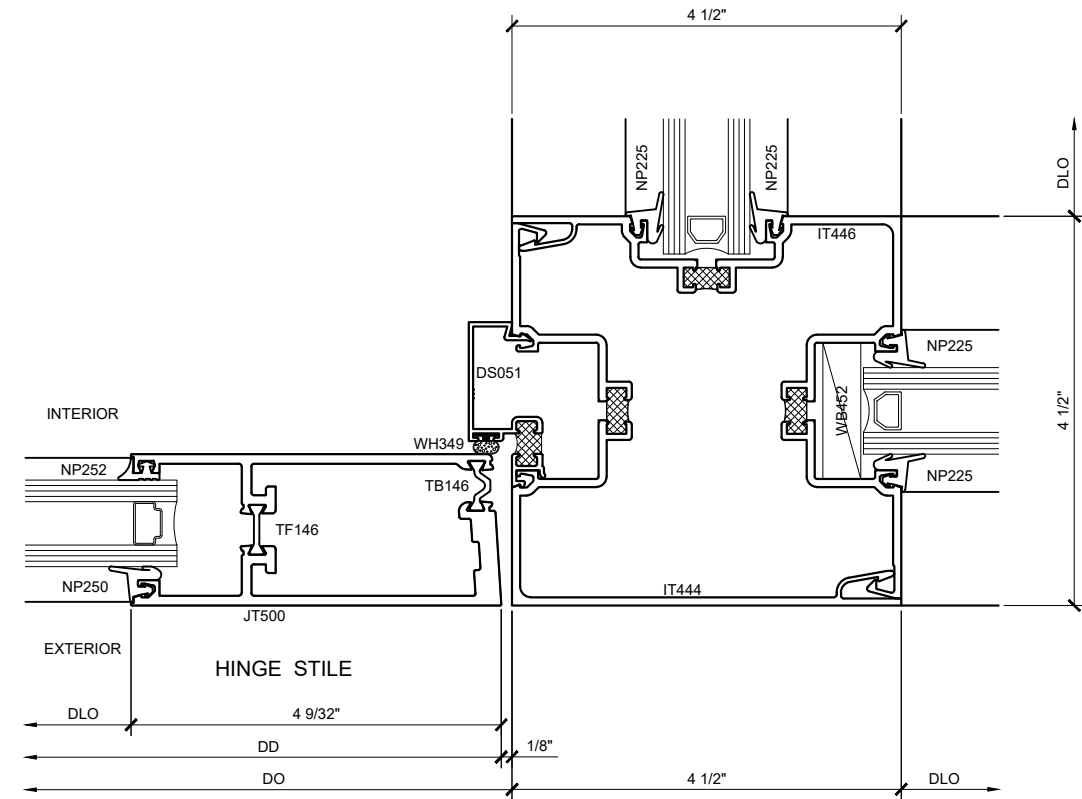

SECTION DETAIL AT WIDE HINGE STYLE
"T" VERTICAL (16)
SCALE: FULL SIZE

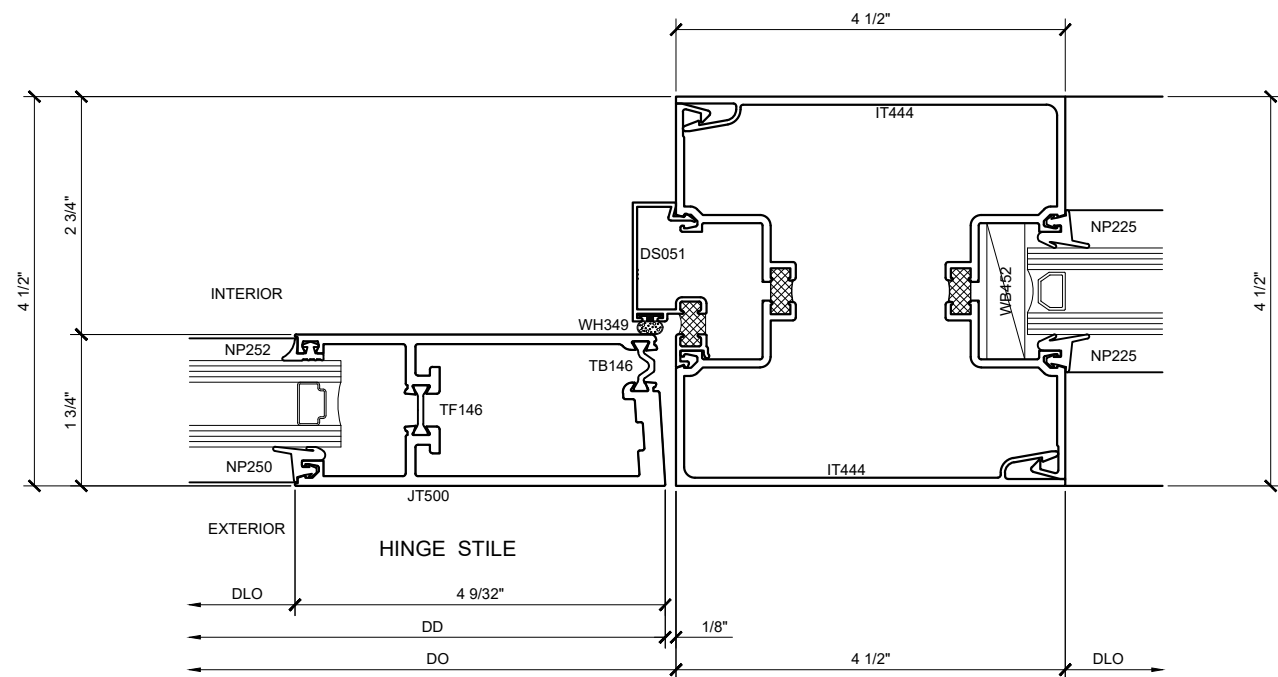

SECTION DETAIL AT WIDE HINGE STYLE
INTERMEDIATE VERTICAL (17)
SCALE: FULL SIZE

MEDIUM STILE OFFSET-HUNG SERIES 400T DOOR DETAILS
SHOWN WITH SERIES IT451 STOREFRONT SYSTEM

| | |
|---------------|----------|
| Revisions By: | |
| TMG | 10/20/17 |
| TMG | 05/05/18 |

U.S. ALUMINUM
C.R. LAURENCE CO. ARCHITECTURAL PRODUCTS
2503 E. Vernon Avenue, Los Angeles, CA 90058-1897
PH: (800) 421-6144 FX: (800) 857-7501 www.crlaurence.com

Description:
U.S. ALUMINUM
MEDIUM STILE SERIES 400T
DOOR SYSTEM

| | |
|------------|----------|
| Drawn By: | RPD |
| Date: | 01/17/17 |
| Scale: | AS NOTED |
| File Name: | 400T.dwg |

Sheet

U.S. ALUMINUM MEDIUM STILE SERIES 400T DOOR SYSTEM

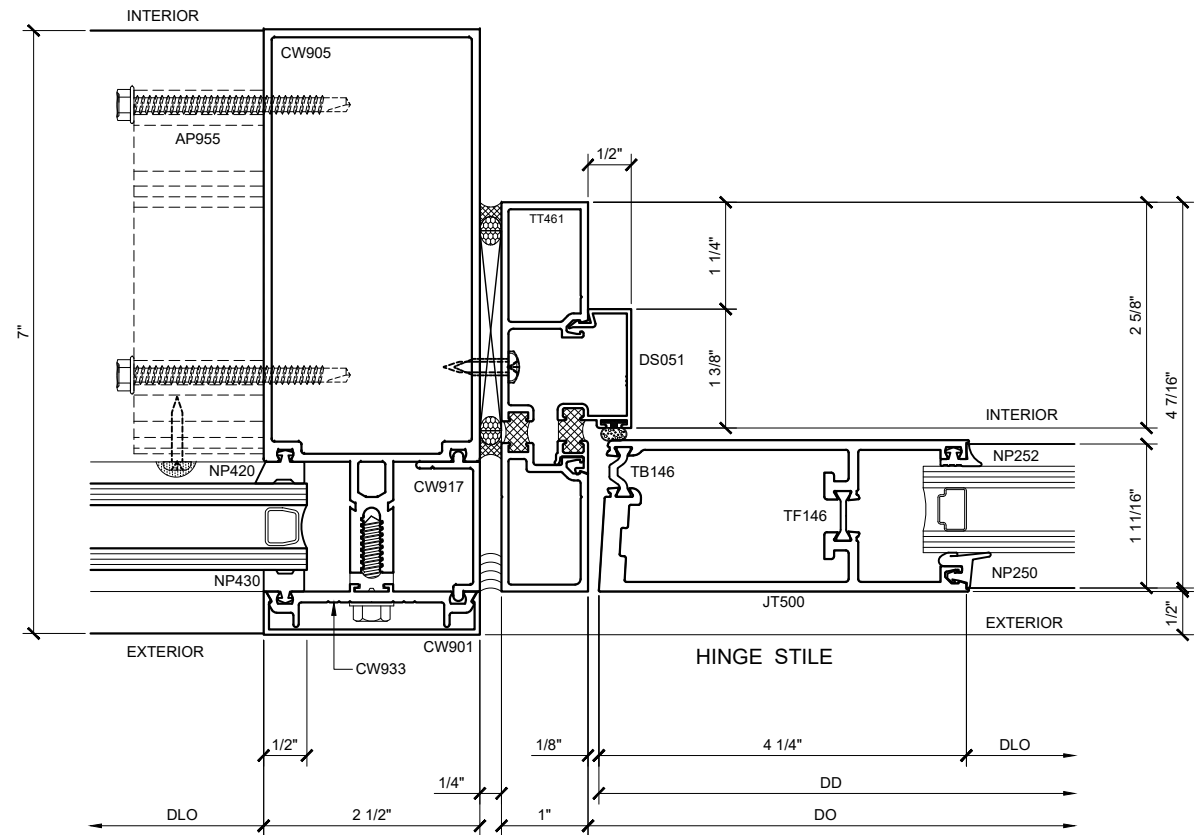

SECTION DETAIL @ DOOR JAMB (20)
SCALE: FULL SIZE

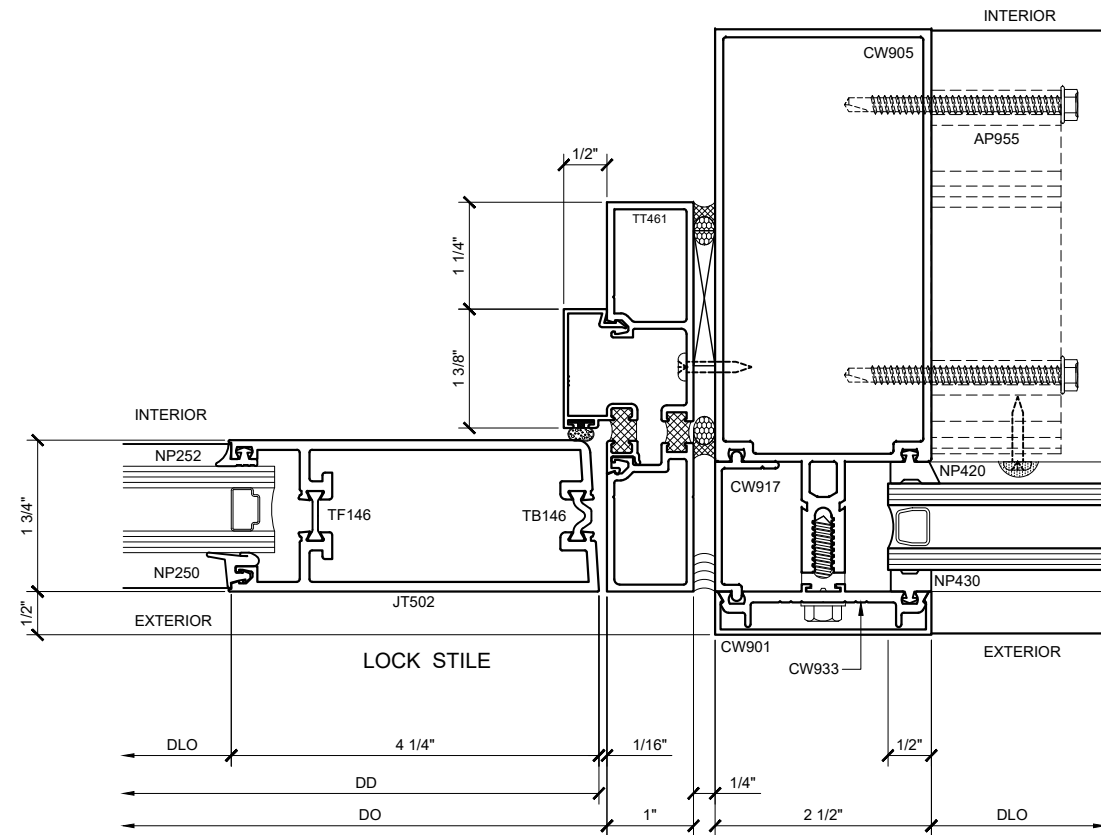

SECTION DETAIL @ DOOR JAMB (21)
SCALE: FULL SIZE

MEDIUM STILE OFFSET-HUNG SERIES 400T DOOR DETAILS
SHOWN WITH SERIES 3250 STOREFRONT SYSTEM

Revisions By:
TMG 10/20/17
TMG 05/05/18

C.R. LAURENCE CO. ARCHITECTURAL PRODUCTS
2503 E. Vernon Avenue, Los Angeles, CA 90058-1897
PH: (800) 421-6144 FX: 800-857-7501 www.crlaurence.com

Description:
U.S. ALUMINUM
MEDIUM STILE SERIES 400T
DOOR SYSTEM

Drawn By: RPD
Date: 01/17/17
Scale: AS NOTED
File Name: 400T.dwg