



U.S. ALUMINUM HIGH PERFORMANCE THERMALLY BROKEN CURTAIN WALL SERIES 3252 / 3252SG SYSTEM

HIGH PERFORMANCE THERMALLY BROKEN CURTAIN WALL SERIES 3252 / 3252SG SYSTEMS SPECIFICATIONS

SPECIAL FEATURES:

- * Extruded Aluminum Mullion Anchors
- * Extruded Shear Blocks are Furnished to Ensure Extra Strong Horizontal to Vertical Joinery
- * Injection Molded End Dams and Closure Plates Used for Controlling Water Infiltration

Complementing the efficiency of insulating glass, Series 3252 Curtain Wall Systems are thermally broken by a continuous Thermal Spacer interlocked with pressure plates and adds our Fill and Debridge Technology. The 3252 uses one Fill and Debridge pocket along with the Thermal Spacer, providing two Thermal Break Points. Dual colors can be achieved by specifying different finishes for the exterior face covers and interior mullions. Two piece horizontals and extruded Shear Blocks allow for a concealed horizontal to vertical joinery without exposed screws. These joint intersections also have concealed injection molded End Dams for controlling any infiltrated water.

SERIES	WIDTH	DEPTH	GLAZING INFILL	APPLICATIONS
3252 3252SG	2-1/2" (63.5)	7" (177.8)	1" (25) and/or 1/4" (6)	Low-Rise to Mid-Rise Buildings Where Exterior Glazing is Required

STANDARD ABBREVIATIONS

RO	ROUGH OPENING
FD	FRAME DIMENSION
DLO	DAYLIGHT OPENING
DO	DOOR OPENING
DD	DOOR DIMENSION
SMC	SURFACE MOUNTED CLOSER
OHCC	OVERHEAD CONCEALED CLOSER

TABLE OF CONTENTS: SERIES 3252 / 3252SG

#	SHEET	DESCRIPTION
1	COVER	TABLE OF CONTENTS / SPECIFICATIONS / SPECIAL FEATURES
2	3252.1.1	CURTAIN WALL SERIES 3252 TYPICAL ELEVATIONS
3	3252.1.2	CURTAIN WALL SERIES 3252 DETAILS
4	3252.1.3	CURTAIN WALL SERIES 3252 DETAILS
5	3252.1.4	CURTAIN WALL SERIES 3252 DETAILS
6	3252.2.1	CURTAIN WALL SERIES 3252SG TYPICAL ELEVATIONS
7	3252.2.2	CURTAIN WALL SERIES 3252SG DETAILS
8	3252.3.1	CURTAIN WALL SERIES 3252 / 3252SG TYPICAL ELEVATIONS
9	3252.3.2	CURTAIN WALL SERIES 3252 / 3252SG DETAILS
10	3252.3.3	CURTAIN WALL SERIES 3252 / 3252SG DETAILS
11	3252.3.4	CURTAIN WALL SERIES 3252 / 3252SG DETAILS
12	3252.4.1	CURTAIN WALL SERIES 3252 TYPICAL ELEVATIONS (W/ DOOR)
13	3252.4.2	CURTAIN WALL SERIES 3252 DETAILS (W/ DOOR)
14	3252.4.3	CURTAIN WALL SERIES 3252 DETAILS (W/ DOOR)
15	3252.4.4	CURTAIN WALL SERIES 3252 DETAILS (W/ DOOR)
16	3252.4.5	CURTAIN WALL SERIES 3252 DETAILS (W/ DOOR)

Revisions By:

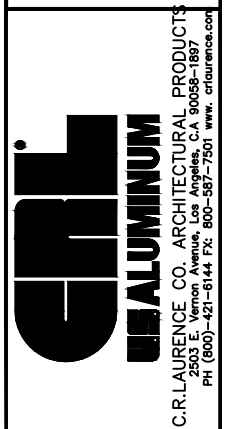

C.R. LAURENCE CO. ARCHITECTURAL PRODUCTS
2503 E. Vernon Avenue, Los Angeles, CA 90058-1897
PH (800)-421-6144 FX: 800-587-7501 www.crlaurence.com

U.S. ALUMINUM SERIES 3252
& 3252SG CURTAIN WALL
HIGH PERFORMANCE
THERMALLY BROKEN

Drawn By: RPD

Date: 12/01/14

Scale: AS NOTED

File Name: 3252.dwg

Sheet

COVER

U.S. ALUMINUM CURTAIN WALL SERIES 3252 SYSTEM

STANDARD ABBREVIATIONS	
RO	ROUGH OPENING
FD	FRAME DIMENSION
DLO	DAYLITE OPENING
DO	DOOR OPENING
DD	DOOR DIMENSION
SMC	SURFACE MOUNTED CLOSER
OHCC	OVERHEAD CONCEALED CLOSER

Revisions By:

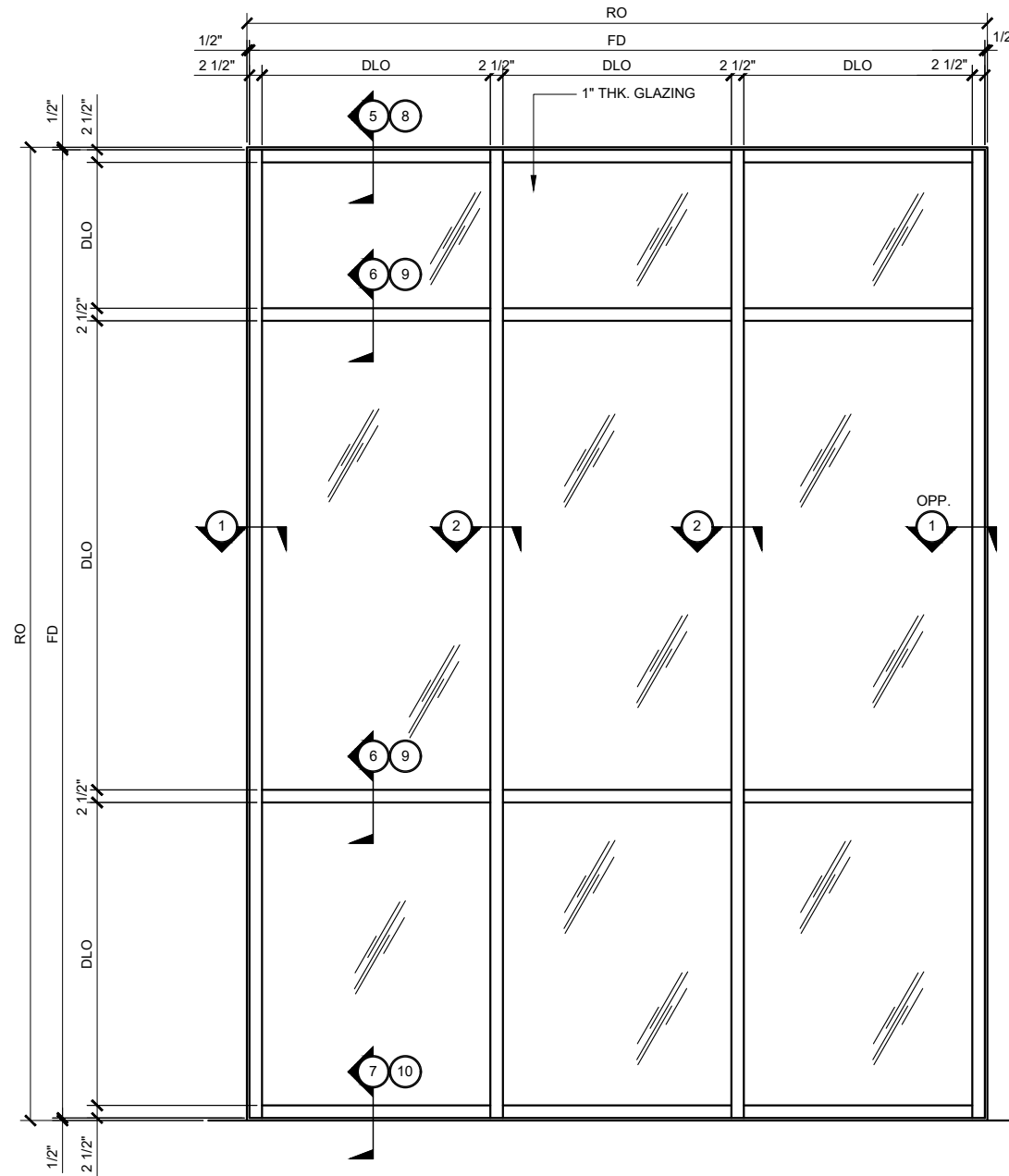

TYPICAL CURTAIN WALL ELEVATION
1" THICK DOUBLE GLAZED 3/4" =1'-0"
5" BACK MEMBER

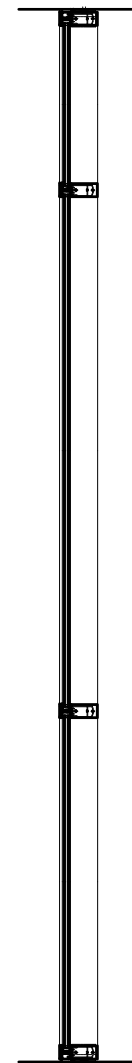

SECTION
3/4" =1'-0"

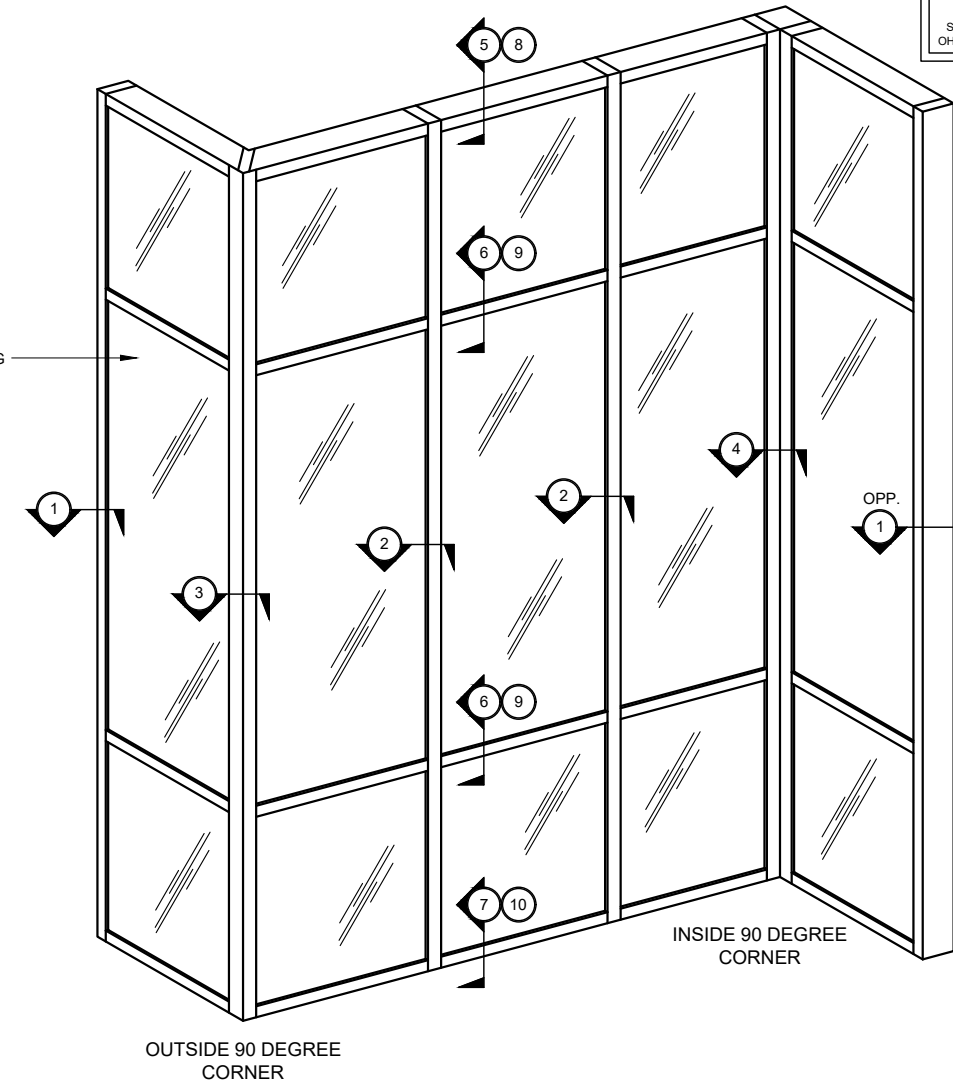

TYPICAL CURTAIN WALL ELEVATION
1" THICK DOUBLE GLAZED 3/4" =1'-0"
5" BACK MEMBER

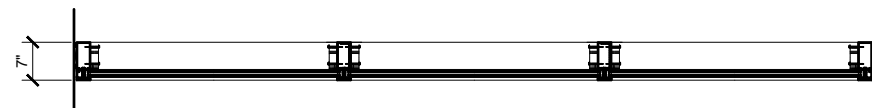

TYPICAL CURTAIN WALL PLAN
1" THICK DOUBLE GLAZED 3/4" =1'-0"
5" BACK MEMBER

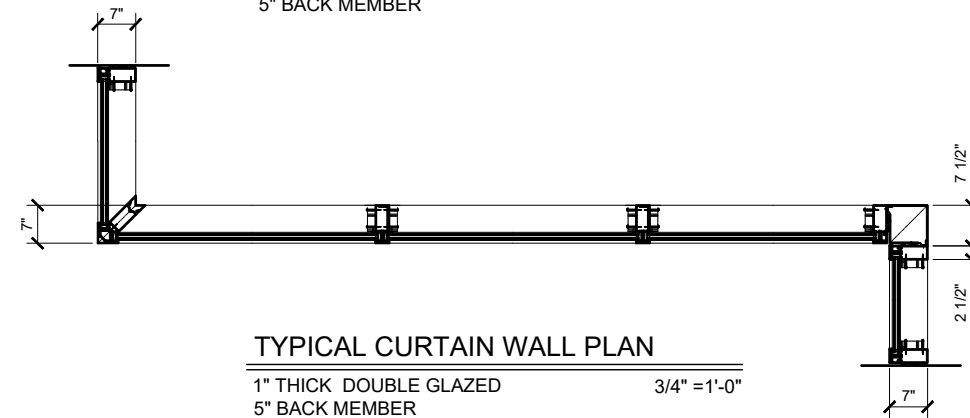

TYPICAL CURTAIN WALL PLAN
1" THICK DOUBLE GLAZED 3/4" =1'-0"
5" BACK MEMBER

NOTE: TUBULAR HORIZONTALS MUST BE USED WHEN SPAN EXCEEDS 6'-0" OR IF DEADLOAD EXCEEDS 250 LBS.

CRL ALUMINUM
C.R.LAURENCE CO. ARCHITECTURAL PRODUCTS
2503 E. Vernon Avenue, Los Angeles, CA 90058-1897
PH (800)-421-6144 FX: 800-587-7501 www.crlaurence.com

Description:
U.S. ALUMINUM SERIES 3252
& 3252SG CURTAIN WALL
HIGH PERFORMANCE
THERMALLY BROKEN

Drawn By: RPD
Date: 12/01/14
Scale: AS NOTED
File Name: 3252.dwg
Sheet

CURTAIN WALL SERIES 3252 TYPICAL ELEVATIONS

3252.1.1 HIGH PERFORMANCE - THERMALLY BROKEN - CAPTURED VERTICAL GLAZED CURTAIN WALL

3252.1.1

NOTES:
 1. 5" BACK MEMBER SHOWN;
 OTHER SIZES AVAILABLE UPON
 REQUEST
 2. PART NUMBERS SHOWN ARE
 AVAILABLE IN 24 FT. STOCK
 LENGTHS. VISIT usalum.com FOR
 MORE INFORMATION

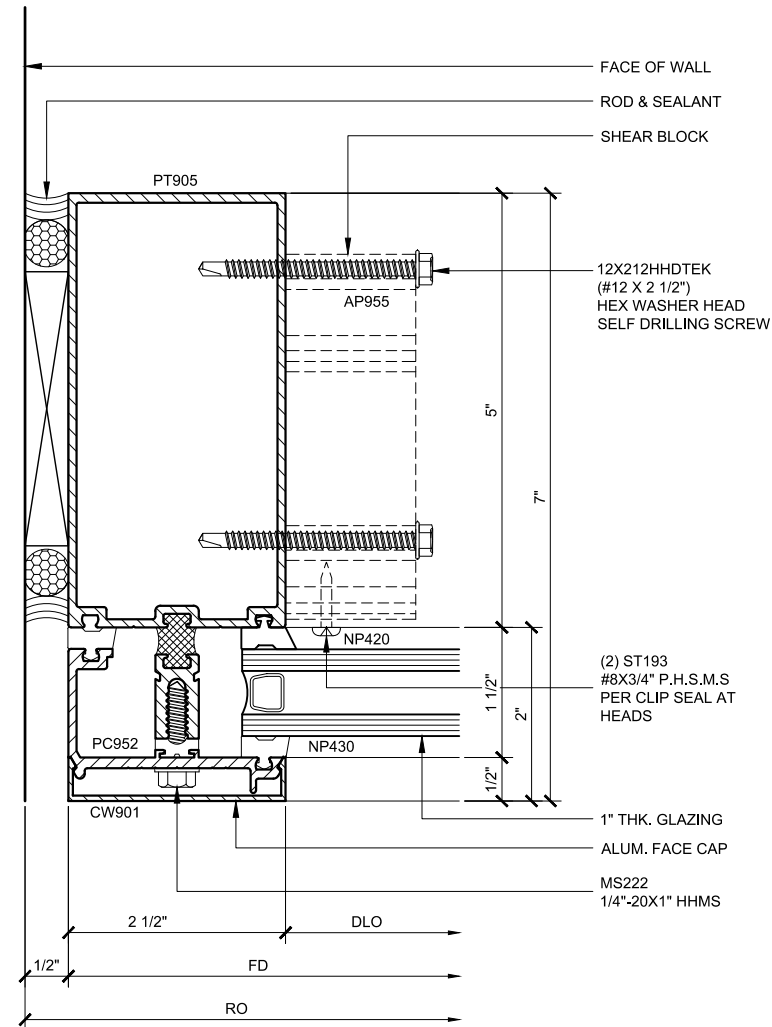

JAMB PLAN 1
 3252.1.2.01
 DOUBLE GLAZED
 5" BACK MEMBER
 1'-0"=1'-0"

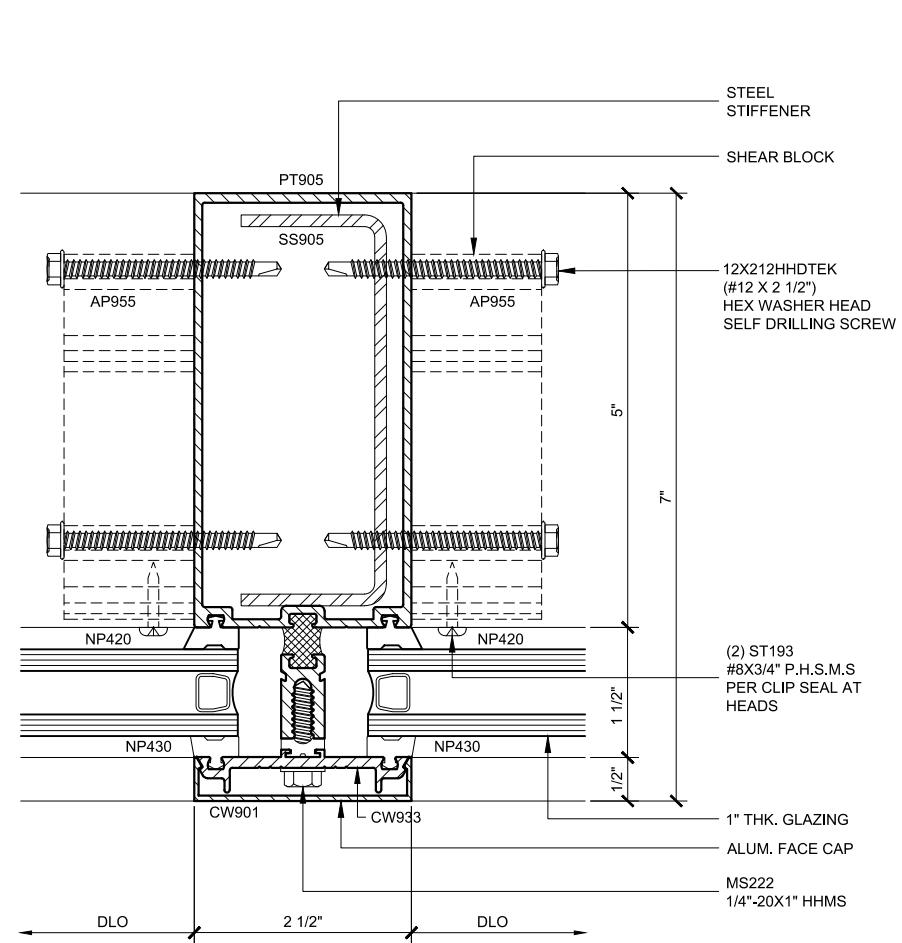

INT. VERT. PLAN 2
 3252.1.2.02
 DOUBLE GLAZED
 5" BACK MEMBER
 1'-0"=1'-0"

CURTAIN WALL SERIES 3252 DETAILS

3252.1.2 - DOUBLE GLAZED - 5" BACK MEMBER

Revisions By:



C.R. LAURENCE CO. ARCHITECTURAL PRODUCTS
 2503 E. Vernon Avenue, Los Angeles, CA 90058-1897
 PH (800)-421-6144 FX: 800-587-7501 www.crlaurence.com

Description:
 U.S. ALUMINUM SERIES 3252
 & 3252SG CURTAIN WALL
 HIGH PERFORMANCE
 THERMALLY BROKEN

Drawn By: RPD
 Date: 12/01/14
 Scale: AS NOTED
 File Name: 3252.dwg
 Sheet

3252.1.2

U.S. ALUMINUM CURTAIN WALL SERIES 3252 SYSTEM

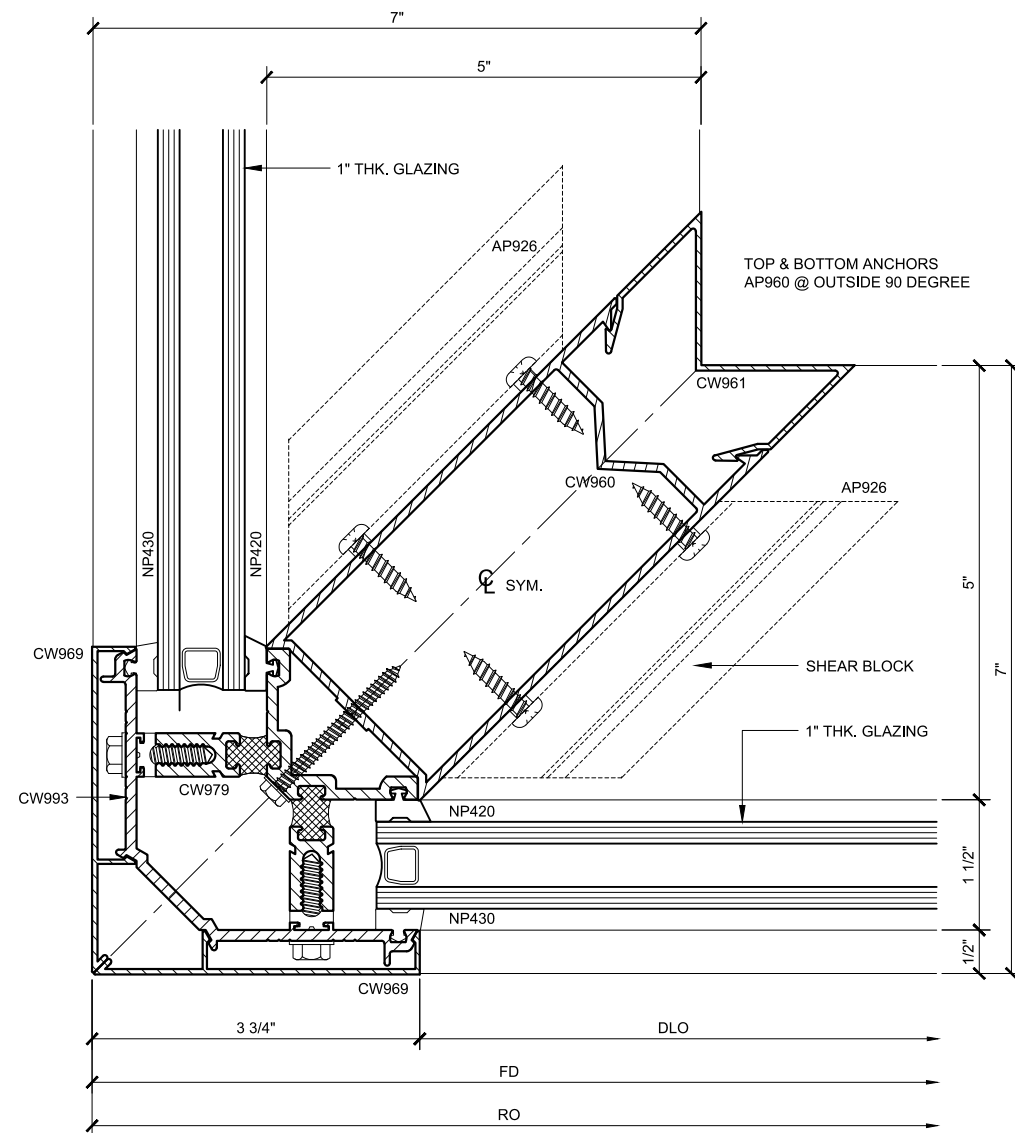

COR. VERT. PLAN 3
 3252.1.3.03
 DOUBLE GLAZED
 5" BACK MEMBER
 1'-0"=1'-0"

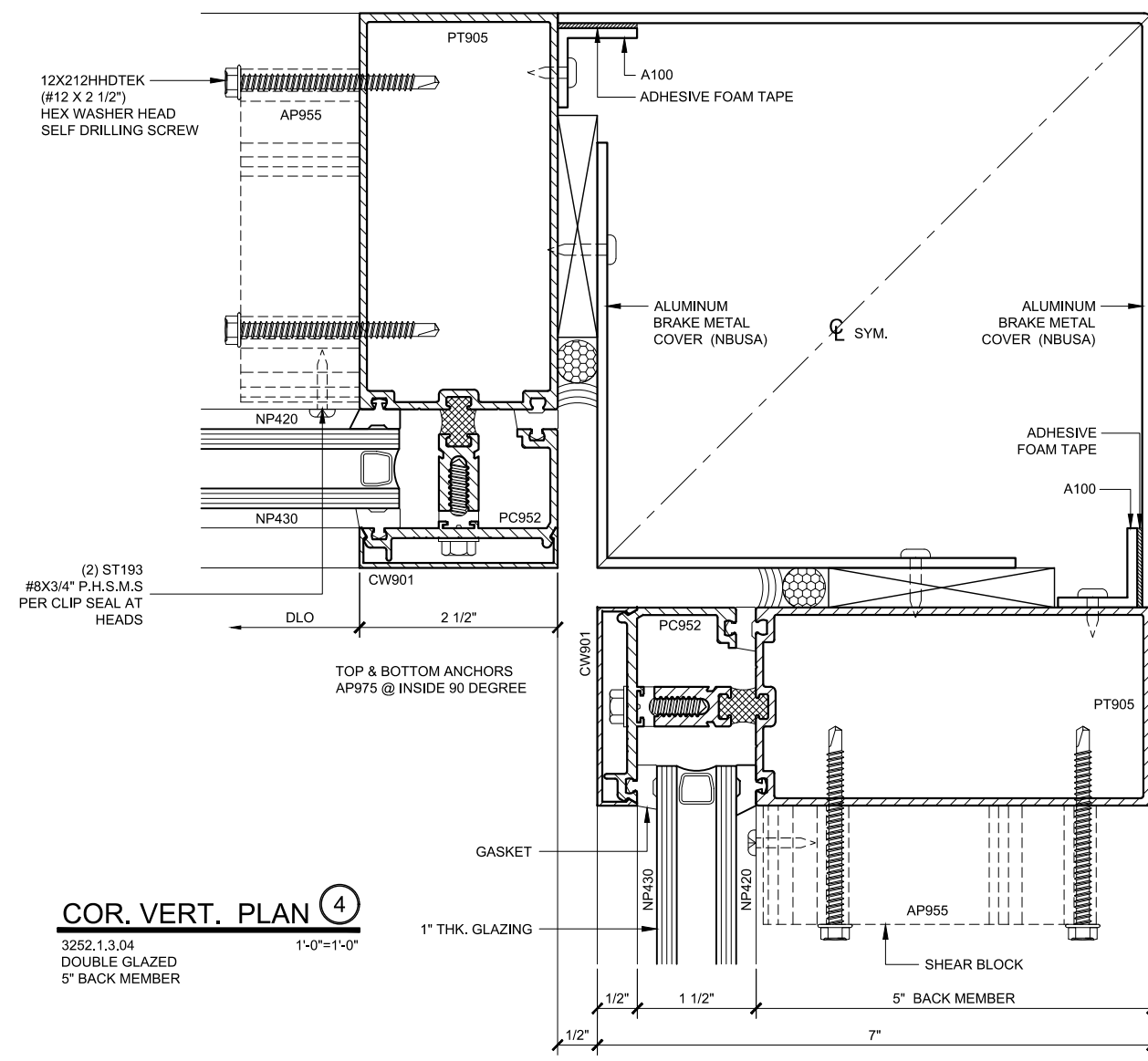

COR. VERT. PLAN 4
 3252.1.3.04
 DOUBLE GLAZED
 5" BACK MEMBER
 1'-0"=1'-0"

NOTES:
 1. 5" BACK MEMBER SHOWN;
 OTHER SIZES AVAILABLE UPON
 REQUEST
 2. PART NUMBERS SHOWN ARE
 AVAILABLE IN 24 FT. STOCK
 LENGTHS. VISIT usalum.com FOR
 MORE INFORMATION

CURTAIN WALL SERIES 3252 DETAILS
 3252.1.3 - DOUBLE GLAZED - 5" BACK MEMBER

Revisions By:

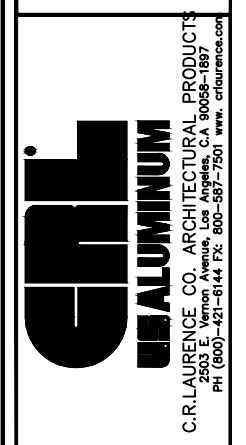

C.R. LAURENCE CO. ARCHITECTURAL PRODUCTS
 2503 E. Vernon Avenue, Los Angeles, CA 90058-1897
 PH (800)-421-6144 FX: 800-587-7501 www.crlaurence.com

Description:
 U.S. ALUMINUM SERIES 3252
 & 3252SG CURTAIN WALL
 HIGH PERFORMANCE
 THERMALLY BROKEN

Drawn By: RPD
 Date: 12/01/14
 Scale: AS NOTED
 File Name: 3252.dwg
 Sheet

3252.1.3

U.S. ALUMINUM CURTAIN WALL SERIES 3252 SYSTEM

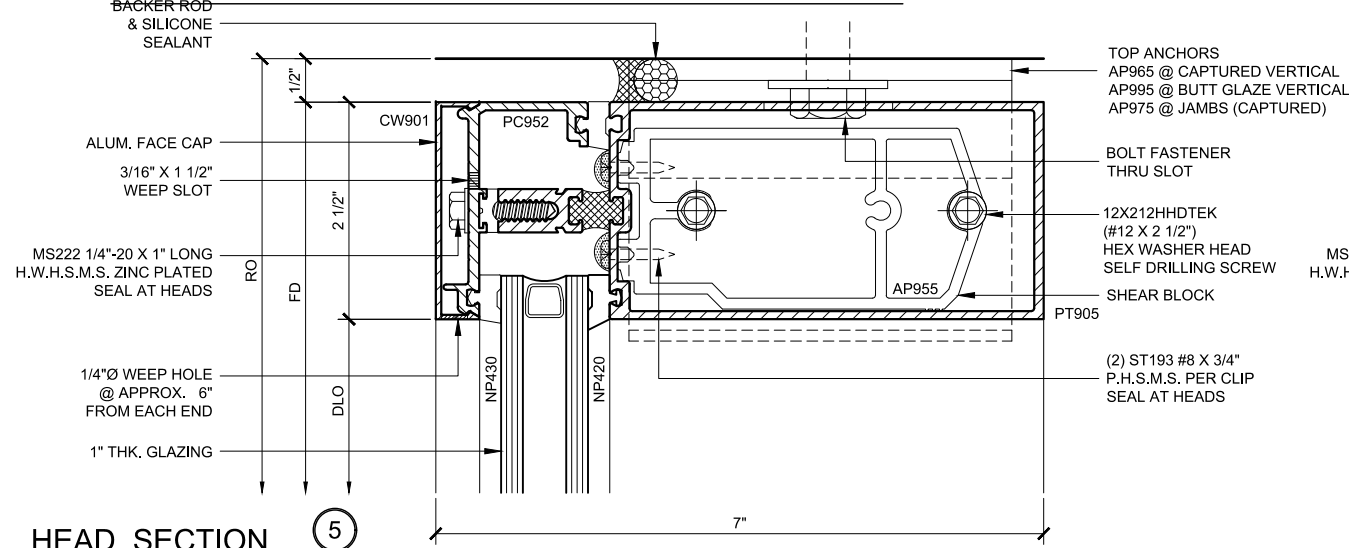

HEAD SECTION 5
3252.1.4.05
DOUBLE GLAZED
5" BACK MEMBER
1'-0"=1'-0"

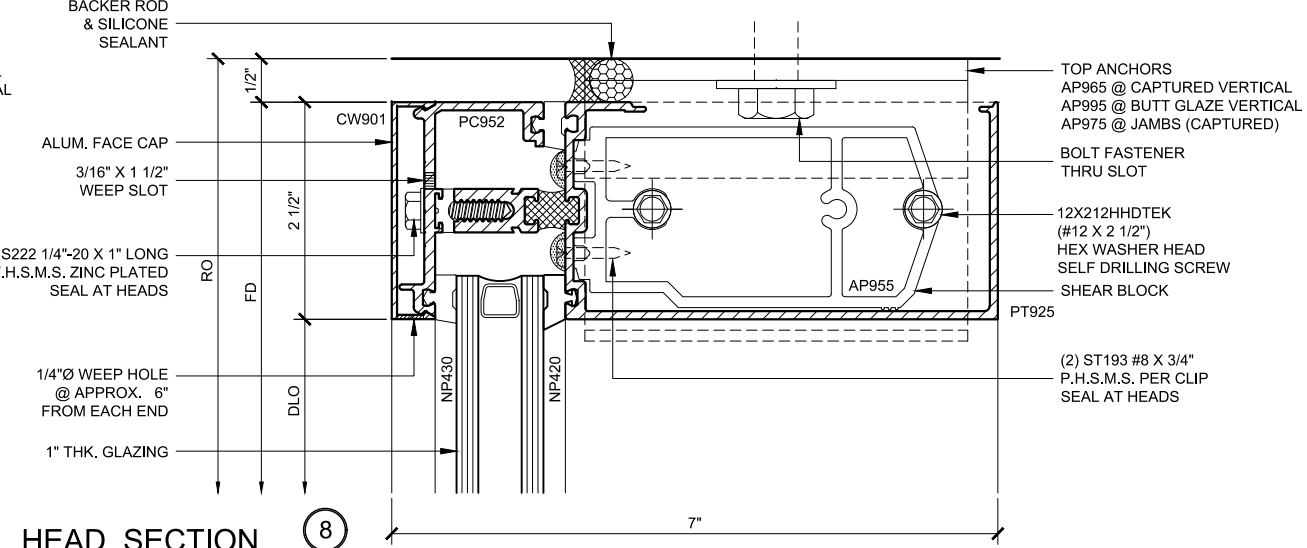

HEAD SECTION 8
3252.1.4.08
DOUBLE GLAZED
5" BACK MEMBER
1'-0"=1'-0"

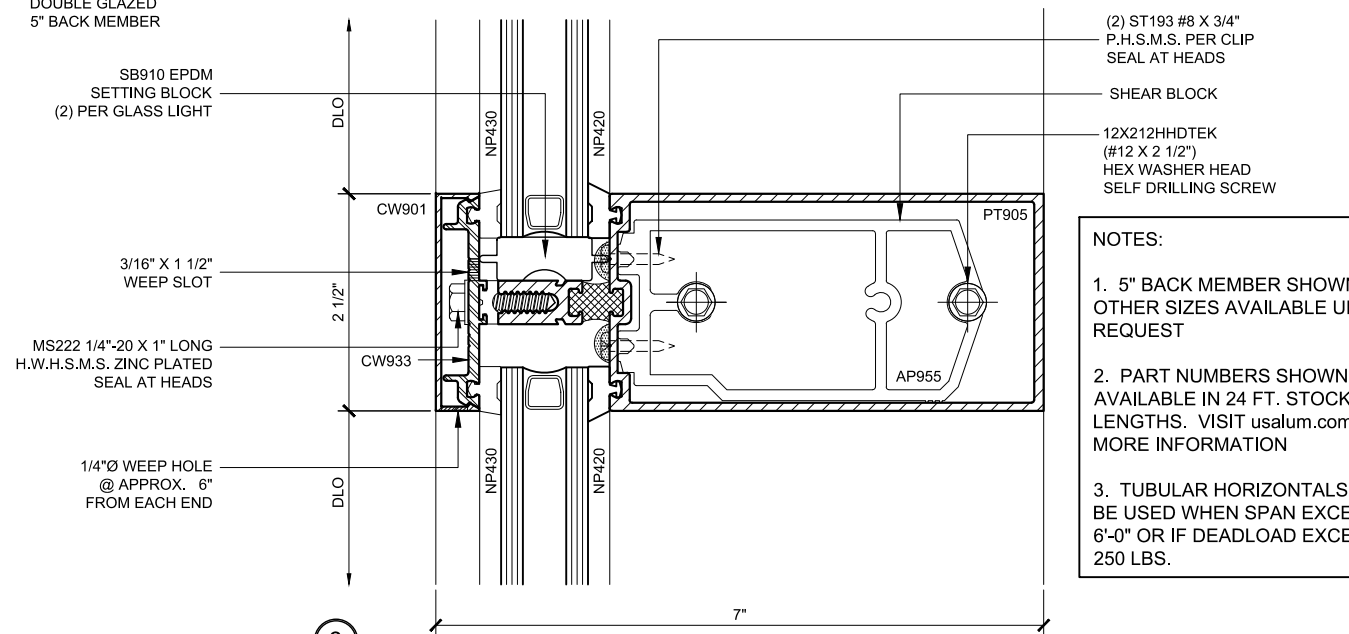

INT. HOR. SECTION 6
3252.1.4.06
DOUBLE GLAZED
5" BACK MEMBER
1'-0"=1'-0"

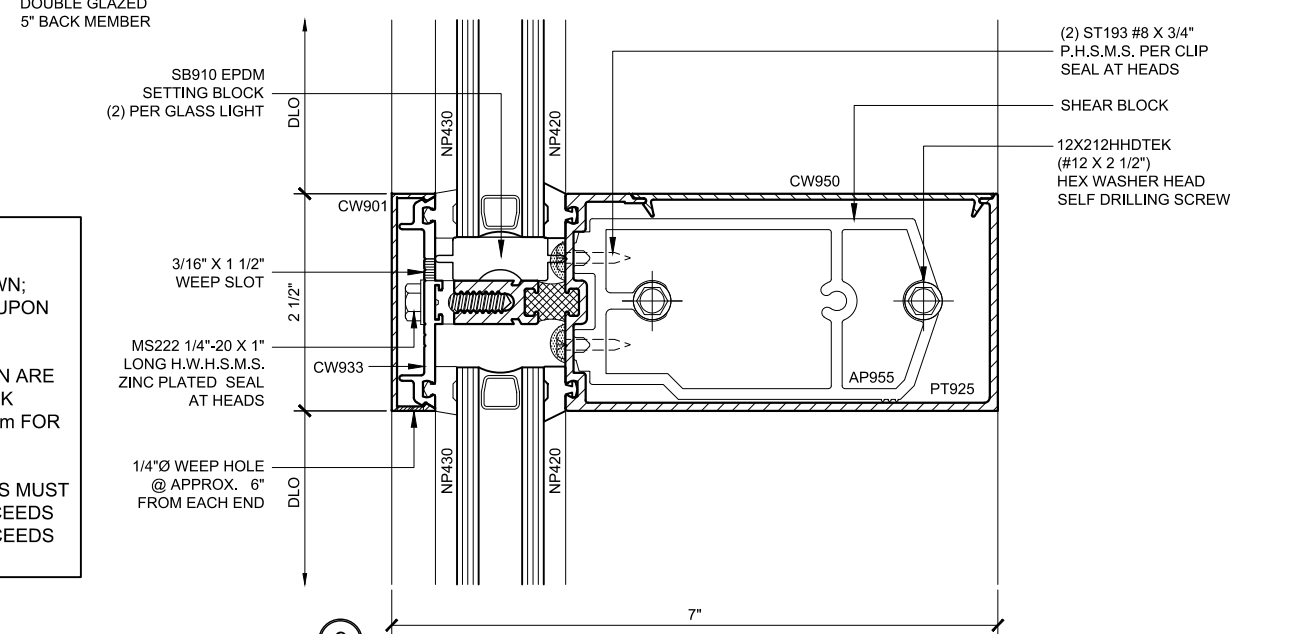

INT. HOR. SECTION 9
3252.1.4.09
DOUBLE GLAZED
5" BACK MEMBER
1'-0"=1'-0"

NOTES:

- 5" BACK MEMBER SHOWN; OTHER SIZES AVAILABLE UPON REQUEST
- PART NUMBERS SHOWN ARE AVAILABLE IN 24 FT. STOCK LENGTHS. VISIT usalum.com FOR MORE INFORMATION
- TUBULAR HORIZONTALS MUST BE USED WHEN SPAN EXCEEDS 6'-0" OR IF DEADLOAD EXCEEDS 250 LBS.

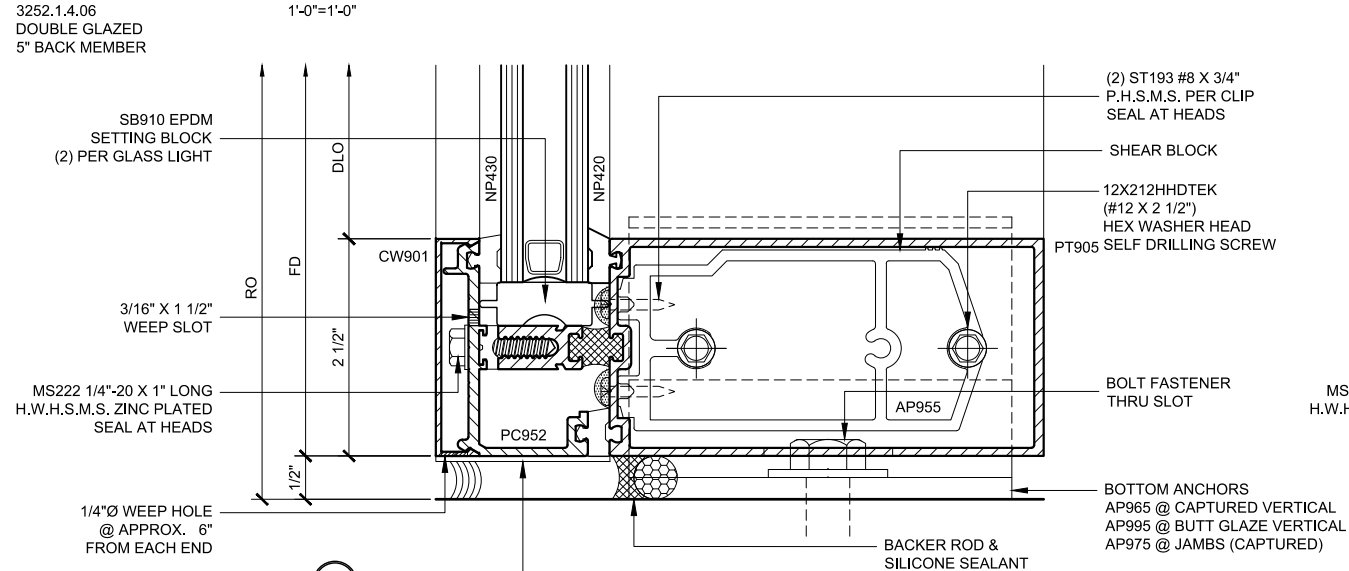

SILL SECTION 7
3252.1.4.07
DOUBLE GLAZED
5" BACK MEMBER
1'-0"=1'-0"

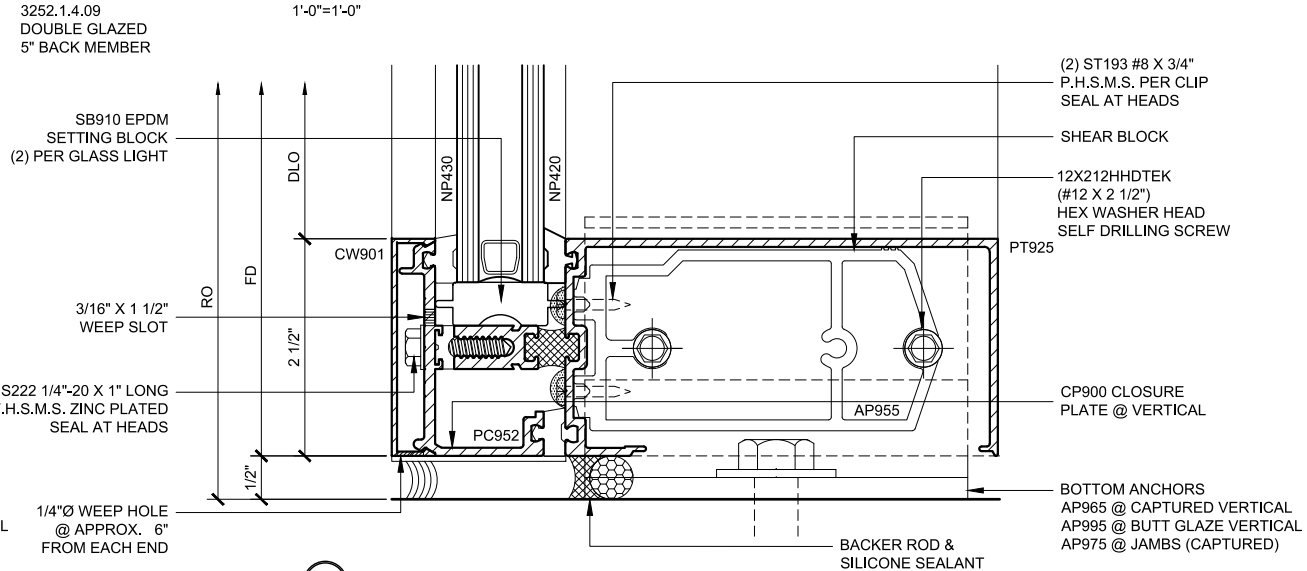

SILL SECTION 10
3252.1.4.10
DOUBLE GLAZED
5" BACK MEMBER
1'-0"=1'-0"

CURTAIN WALL SERIES 3252 DETAILS

3252.1.4 - DOUBLE GLAZED - 5" BACK MEMBER

Revisions By:

ALUMINUM
C.R. LAURENCE CO. ARCHITECTURAL PRODUCTS
2503 E. Vernon Avenue, Los Angeles, CA 90058-1897
PH (800)-421-6144 FX: 800-587-7501 www.crlaurence.com

Description:
U.S. ALUMINUM SERIES 3252
& 3252SG CURTAIN WALL
HIGH PERFORMANCE
THERMALLY BROKEN

Drawn By: RPD
Date: 12/01/14
Scale: AS NOTED
File Name: 3252.dwg
Sheet

3252.1.4

U.S. ALUMINUM CURTAIN WALL SERIES 3252SG SYSTEM

STANDARD ABBREVIATIONS	
RO	ROUGH OPENING
FD	FRAME DIMENSION
DLO	DAYLITE OPENING
DO	DOOR OPENING
DD	DOOR DIMENSION
SMC	SURFACE MOUNTED CLOSER
OHCC	OVERHEAD CONCEALED CLOSER

Revisions By:

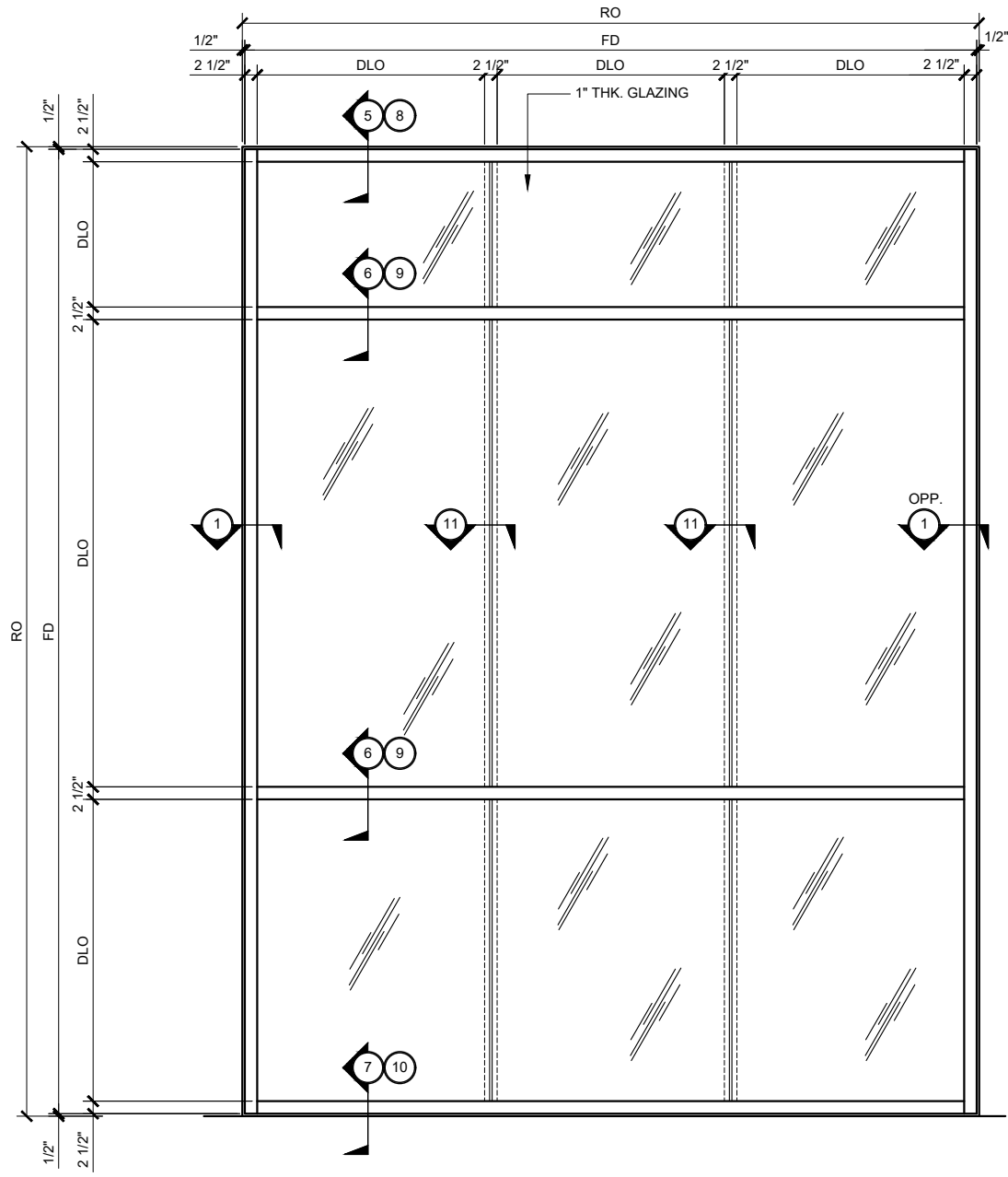

TYPICAL CURTAIN WALL ELEVATION
 1" THICK DOUBLE GLAZED 3/4" = 1'-0"
 5" BACK MEMBER

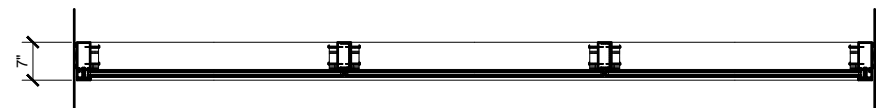

TYPICAL CURTAIN WALL PLAN
 1" THICK DOUBLE GLAZED 3/4" = 1'-0"
 5" BACK MEMBER

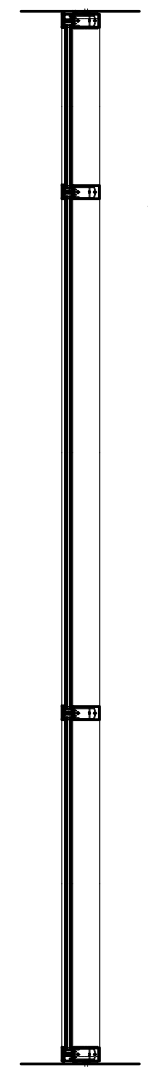

SECTION
 3/4" = 1'-0"

NOTE: TUBULAR HORIZONTALS MUST BE USED WHEN SPAN EXCEEDS 6'-0" OR IF DEADLOAD EXCEEDS 250 LBS.

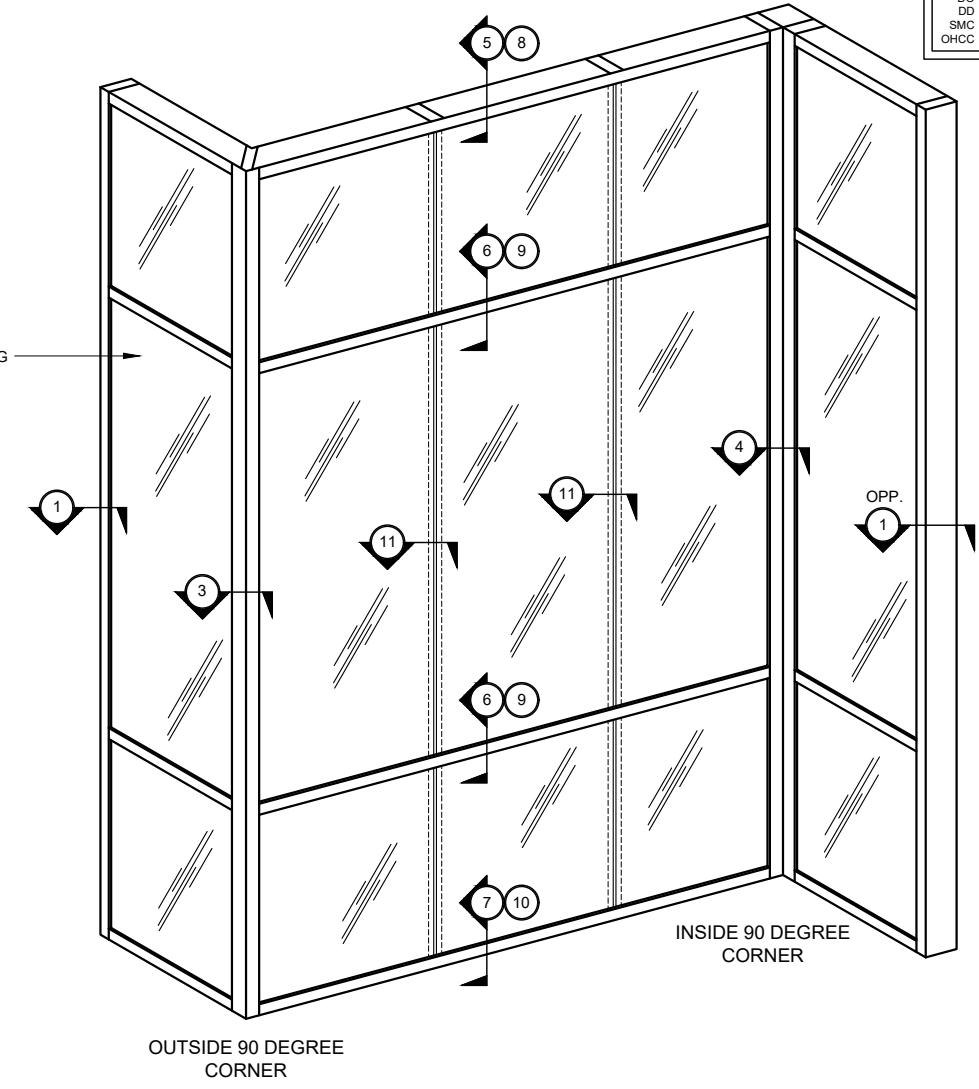

TYPICAL CURTAIN WALL ELEVATION
 1" THICK DOUBLE GLAZED 3/4" = 1'-0"
 5" BACK MEMBER

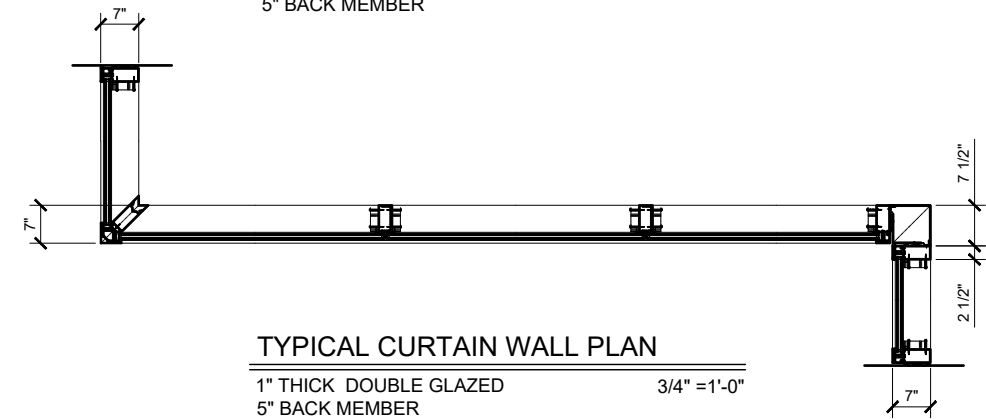

TYPICAL CURTAIN WALL PLAN
 1" THICK DOUBLE GLAZED 3/4" = 1'-0"
 5" BACK MEMBER

CRL ALUMINUM
 C.R. LAURENCE CO. ARCHITECTURAL PRODUCTS
 2503 E. Vernon Avenue, Los Angeles, CA 90058-1897
 PH (800)-421-6144 FX: 800-587-7501 www.crlaurence.com

Description:
 U.S. ALUMINUM SERIES 3252
 & 3252SG CURTAIN WALL
 HIGH PERFORMANCE
 THERMALLY BROKEN

Drawn By: RPD
 Date: 12/01/14
 Scale: AS NOTED
 File Name: 3252.dwg

Sheet

CURTAIN WALL SERIES 3252SG TYPICAL ELEVATIONS

3252.2.1 HIGH PERFORMANCE - THERMALLY BROKEN - STRUCTURAL SILICONE VERT. GLAZED CURTAIN WALL

3252.2.1

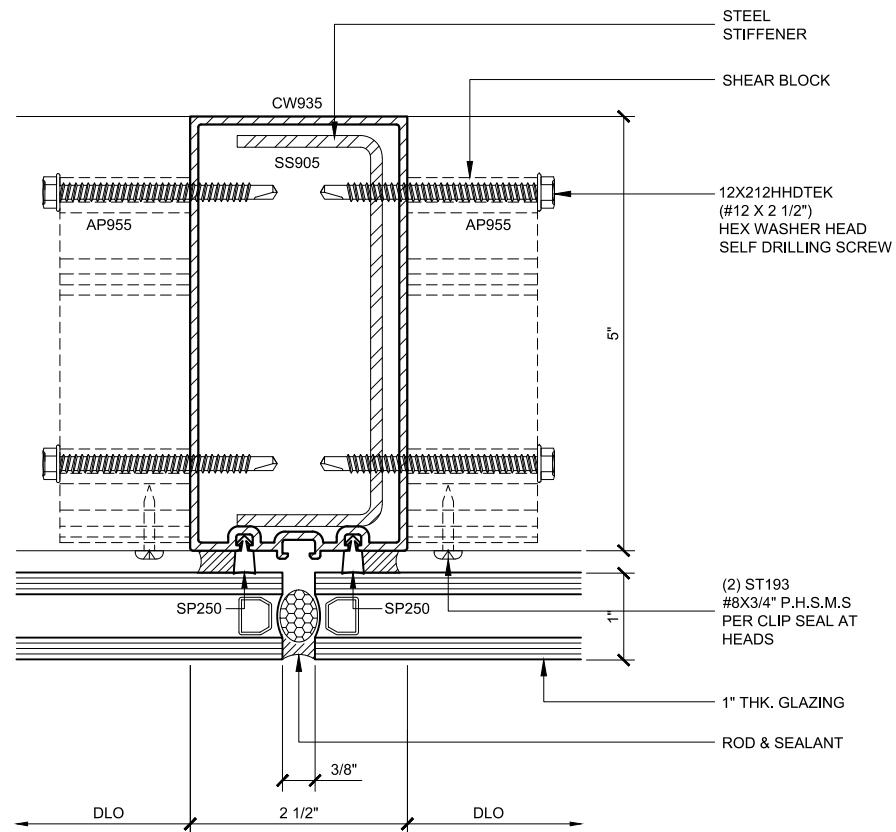

NOTES:

1. 5" BACK MEMBER SHOWN; OTHER SIZES AVAILABLE UPON REQUEST
2. PART NUMBERS SHOWN ARE AVAILABLE IN 24 FT. STOCK LENGTHS. VISIT usalum.com FOR MORE INFORMATION

INT. VERT. PLAN (11)
 3252.2.2.11 (3252SG SERIES) 1'-0"=1'-0"
 DOUBLE GLAZED
 5" BACK MEMBER

CURTAIN WALL SERIES 3252SG DETAILS
 3252.2.2 - DOUBLE GLAZED - 5" BACK MEMBER

Revisions By:

C.R. LAURENCE CO. ARCHITECTURAL PRODUCTS
 2503 E. Vernon Avenue, Los Angeles, CA 90058-1897
 PH (800)-421-6144 FX: 800-587-7501 www.crlaurence.com

Description:
 U.S. ALUMINUM SERIES 3252
 & 3252SG CURTAIN WALL
 HIGH PERFORMANCE
 THERMALLY BROKEN

Drawn By: RPD
 Date: 12/01/14
 Scale: AS NOTED
 File Name: 3252.dwg
 Sheet

3252.2.2

STANDARD ABBREVIATIONS	
RO	ROUGH OPENING
FD	FRAME DIMENSION
DLO	DAYLITE OPENING
DO	DOOR OPENING
DD	DOOR DIMENSION
SMC	SURFACE MOUNTED CLOSER
OHCC	OVERHEAD CONCEALED CLOSER

Revisions By:

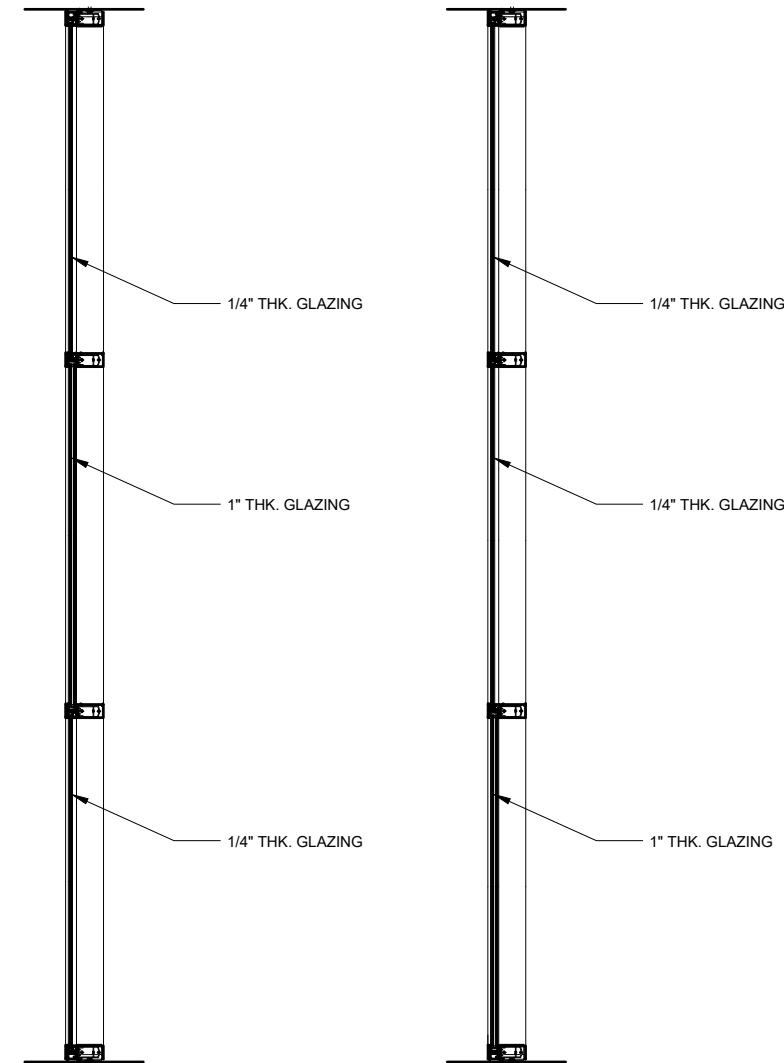
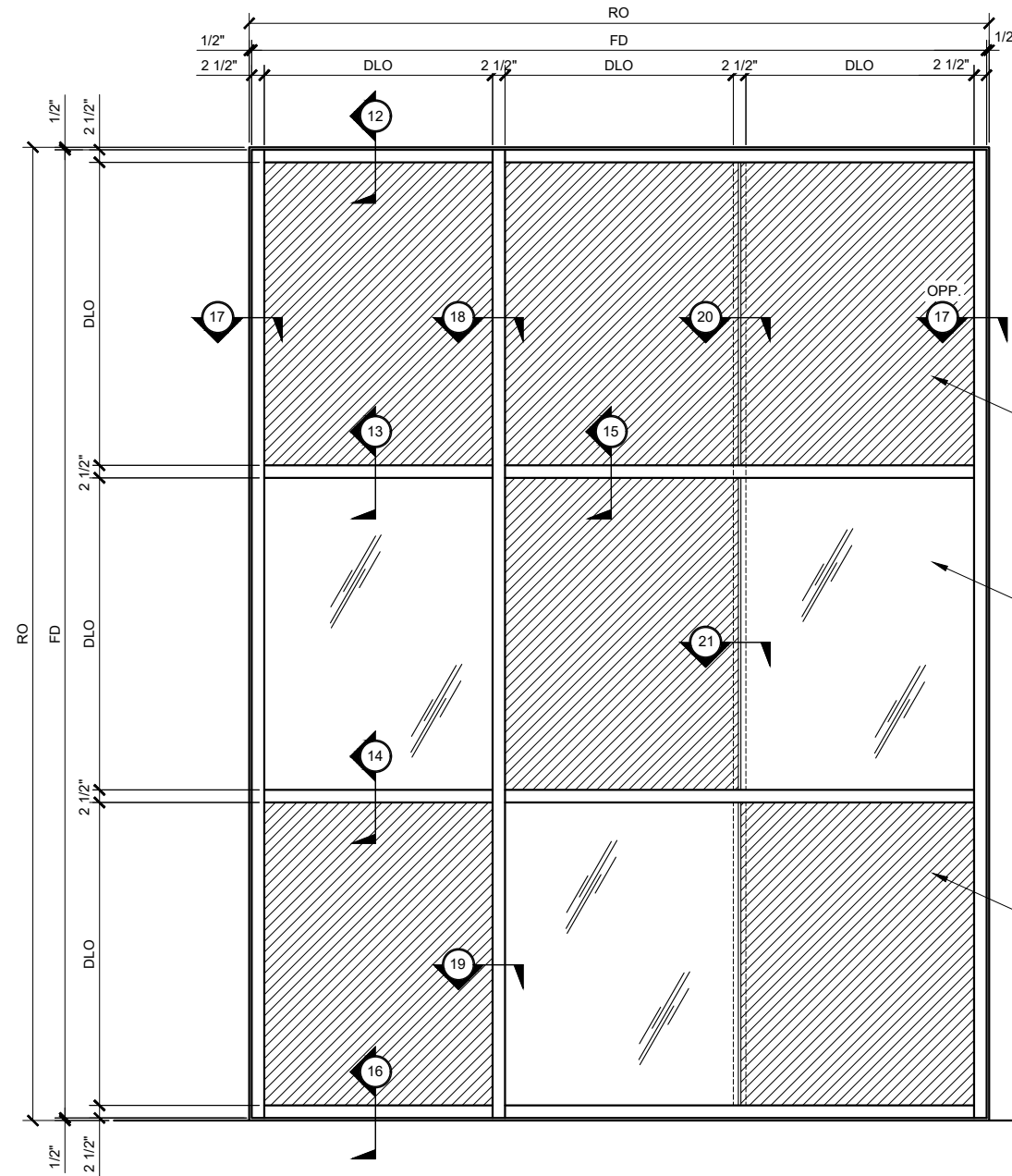

TYPICAL CURTAIN WALL ELEVATION

1" TO 1/4" TRANSITION GLAZING 3/4" =1'-0"
 5" BACK MEMBER

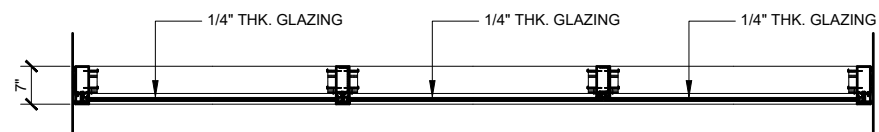

TYPICAL CURTAIN WALL PLAN

1" TO 1/4" TRANSITION GLAZING 3/4" =1'-0"
 5" BACK MEMBER

SECTION

3/4" =1'-0"

SECTION

3/4" =1'-0"

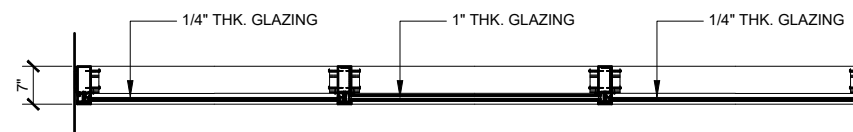

TYPICAL CURTAIN WALL PLAN

1" TO 1/4" TRANSITION GLAZING 3/4" =1'-0"
 5" BACK MEMBER

CRL ALUMINUM
 C.R.LAURENCE CO. ARCHITECTURAL PRODUCTS
 2503 E. Vernon Avenue, Los Angeles, CA 90058-1897
 PH (800)-421-6144 FX: 800-587-7501 www.crlaurence.com

Description:
 U.S. ALUMINUM SERIES 3252
 & 3252SG CURTAIN WALL
 HIGH PERFORMANCE
 THERMALLY BROKEN

Drawn By: RPD
 Date: 12/01/14
 Scale: AS NOTED
 File Name: 3252.dwg

Sheet

3252.3.1

CURTAIN WALL SERIES 3252 / 3252SG TYPICAL ELEVATIONS

3252.3.1 HIGH PERFORMANCE - THERMALLY BROKEN - COMBINATION CAPTURED VERTICAL GLAZED CURTAIN WALL AND STRUCTURAL SILICONE VERTICAL GLAZED CURTAIN WALL

U.S. ALUMINUM CURTAIN WALL SERIES 3252 SYSTEM

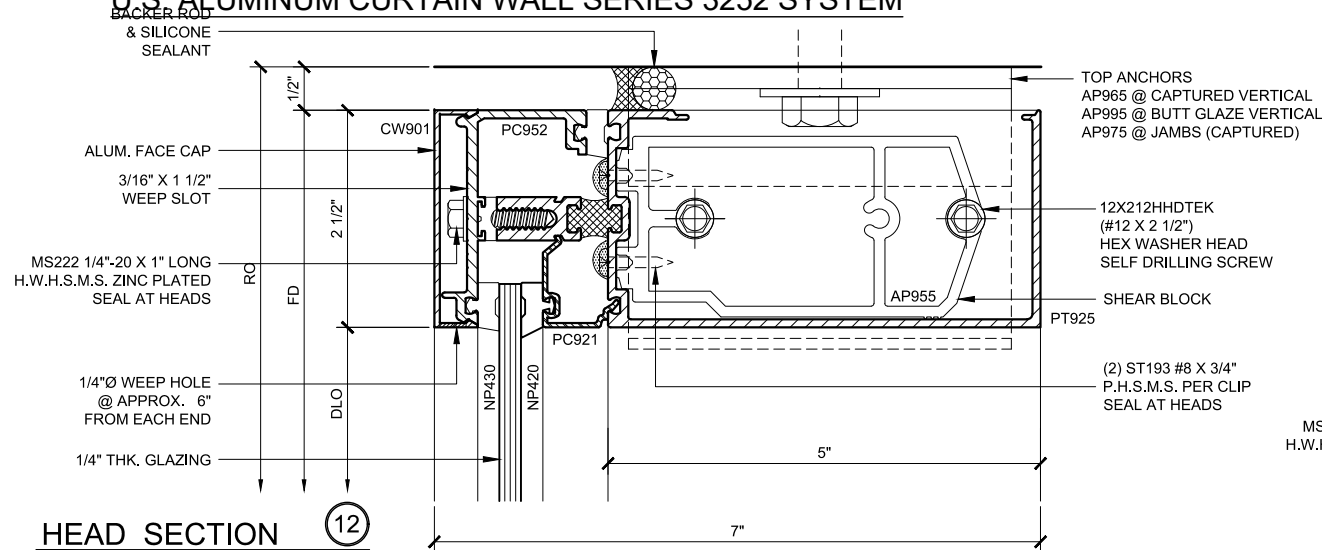

HEAD SECTION 12
3252.3.2.12
SINGLE GLAZED
5\"/>

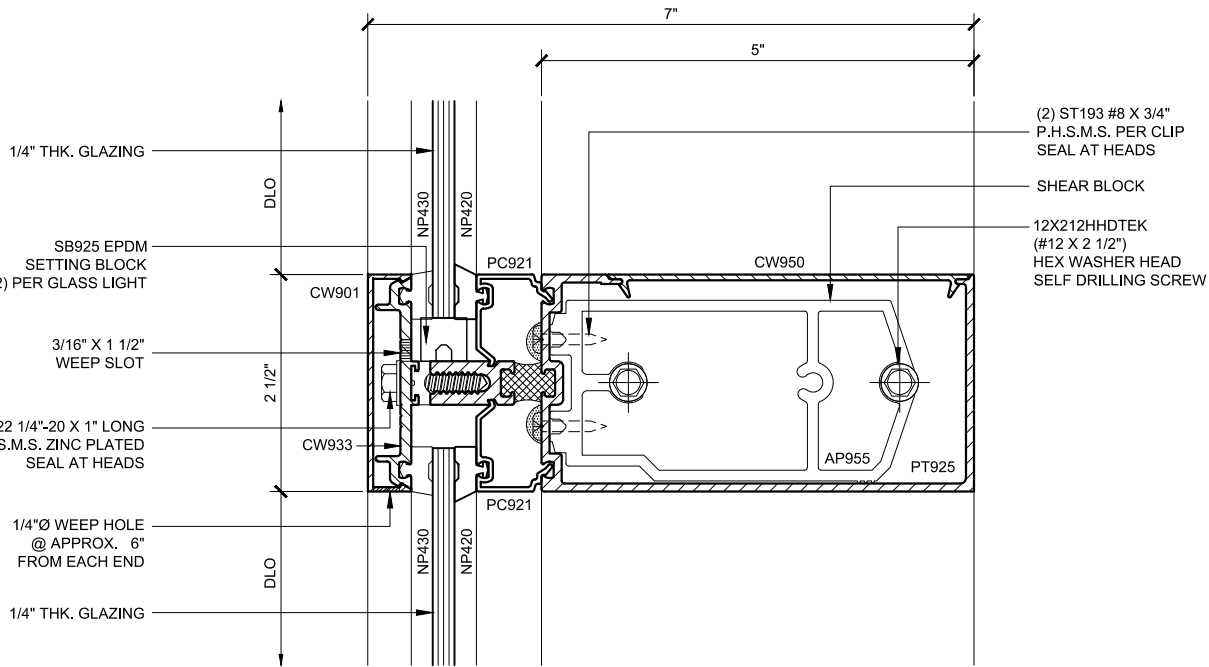

INT. HORIZ. SECTION 15
3252.3.2.15
SINGLE GLAZED
5\"/>

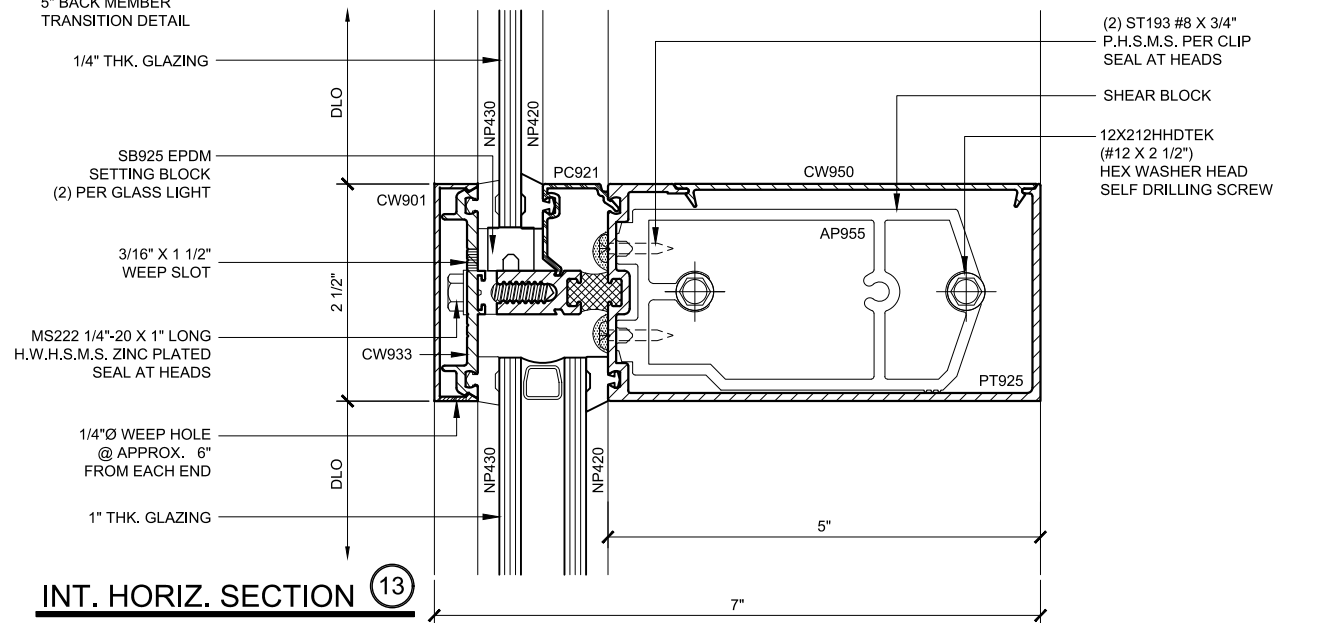

INT. HORIZ. SECTION 13
3252.3.2.13
SINGLE / DOUBLE GLAZED
5\"/>

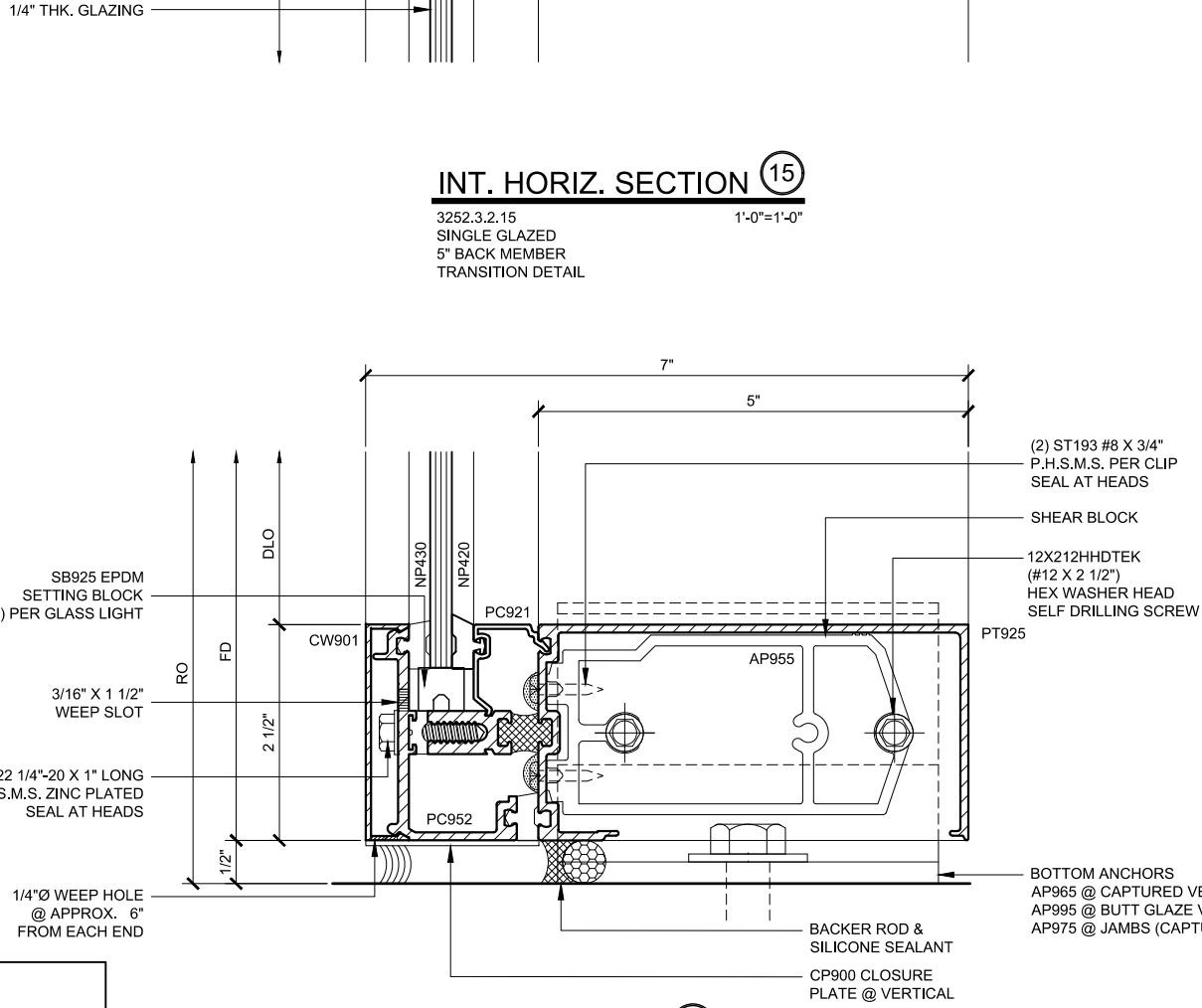

SILL SECTION 16
3252.3.2.16
SINGLE GLAZED
5\"/>

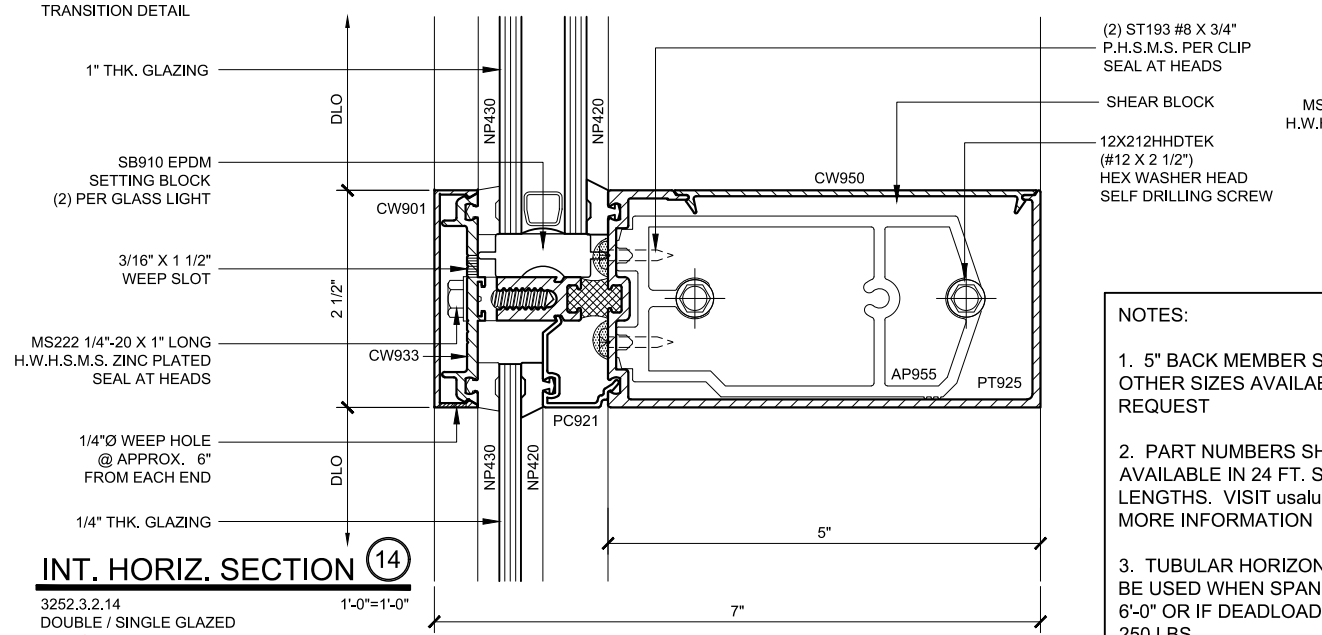

INT. HORIZ. SECTION 14
3252.3.2.14
DOUBLE / SINGLE GLAZED
5\"/>

- NOTES:**
- 5\"/>
 - PART NUMBERS SHOWN ARE AVAILABLE IN 24 FT. STOCK LENGTHS. VISIT usalum.com FOR MORE INFORMATION
 - TUBULAR HORIZONTALS MUST BE USED WHEN SPAN EXCEEDS 6'-0\"/>

CURTAIN WALL SERIES 3252 DETAILS

3252.3.2 - TRANSITION SINGLE / DOUBLE GLAZED - 5\"/>

Revisions By:

ALUMINUM
C.R. LAURENCE CO. ARCHITECTURAL PRODUCTS
2503 E. Vernon Avenue, Los Angeles, CA 90058-1897
PH (800)-421-6144 FX: 800-587-7501 www.crlaurence.com

U.S. ALUMINUM SERIES 3252
& 3252SG CURTAIN WALL
HIGH PERFORMANCE
THERMALLY BROKEN

Drawn By: RPD
Date: 12/01/14
Scale: AS NOTED
File Name: 3252.dwg

Sheet
3252.3.2

U.S. ALUMINUM CURTAIN WALL SERIES 3252 SYSTEM

NOTES:
 1. 5" BACK MEMBER SHOWN;
 OTHER SIZES AVAILABLE UPON
 REQUEST
 2. PART NUMBERS SHOWN ARE
 AVAILABLE IN 24 FT. STOCK
 LENGTHS. VISIT usalum.com FOR
 MORE INFORMATION

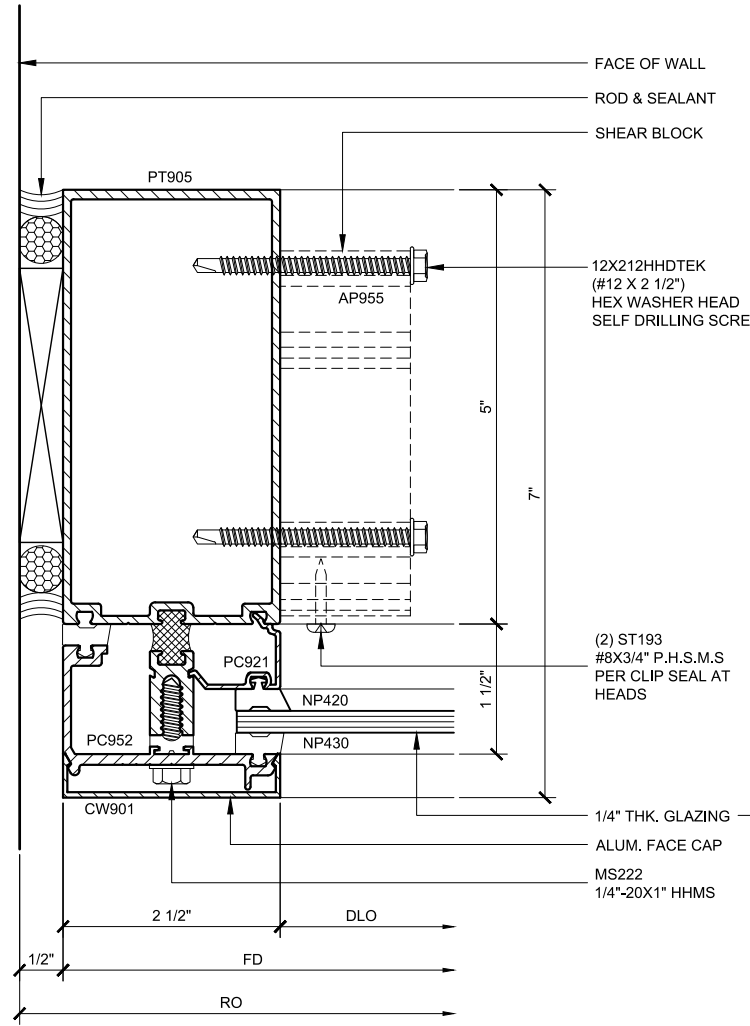

JAMB PLAN 17
 3252.3.3.17
 SINGLE GLAZED
 5" BACK MEMBER
 TRANSITION DETAIL
 1'-0"=1'-0"

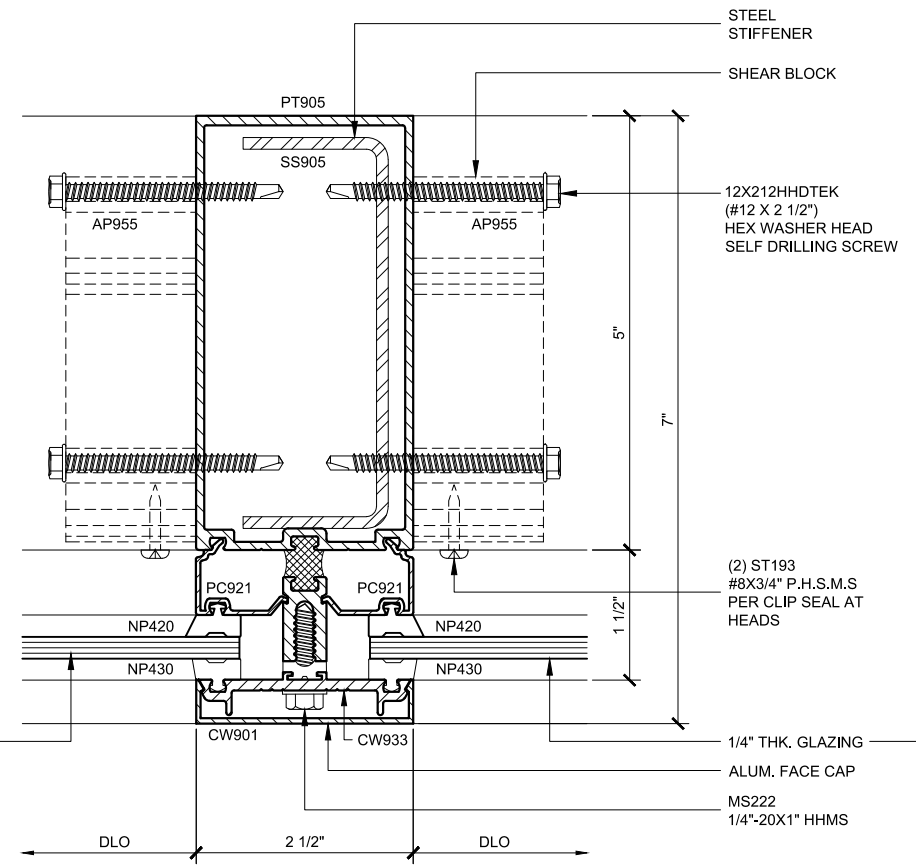

INT. VERT. PLAN 18
 3252.3.3.18
 SINGLE GLAZED
 5" BACK MEMBER
 TRANSITION DETAIL
 1'-0"=1'-0"

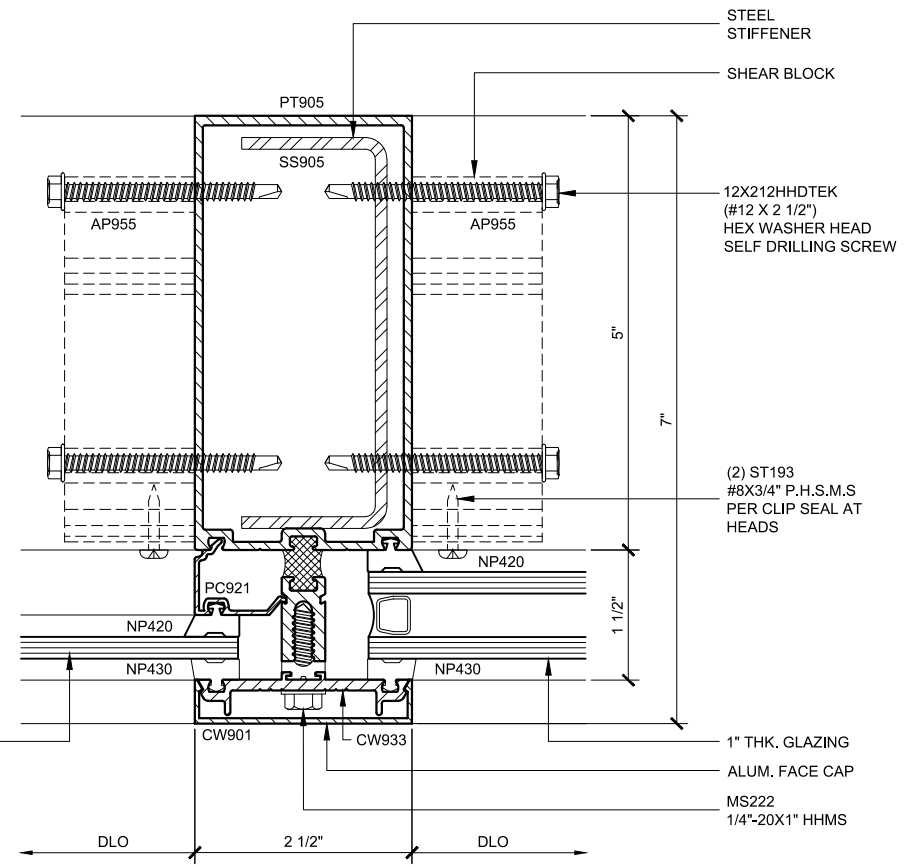

INT. VERT. PLAN 19
 3252.3.3.19
 SINGLE / DOUBLE GLAZED
 5" BACK MEMBER
 TRANSITION DETAIL
 1'-0"=1'-0"

CURTAIN WALL SERIES 3252 DETAILS
 3252.3.3 - TRANSITION SINGLE / DOUBLE GLAZED - 5" BACK MEMBER

Revisions By:

 C.R. LAURENCE CO. ARCHITECTURAL PRODUCTS
 2503 E. Vernon Avenue, Los Angeles, CA 90058-1897
 PH (800)-421-6144 FX: 800-587-7501 www.crlaurence.com

Discription:
 U.S. ALUMINUM SERIES 3252
 & 3252SG CURTAIN WALL
 HIGH PERFORMANCE
 THERMALLY BROKEN

Drawn By: RPD
 Date: 12/01/14
 Scale: AS NOTED
 File Name: 3252.dwg
 Sheet

3252.3.3

U.S. ALUMINUM CURTAIN WALL SERIES 3252SG SYSTEM

NOTES:
 1. 5" BACK MEMBER SHOWN;
 OTHER SIZES AVAILABLE UPON
 REQUEST
 2. PART NUMBERS SHOWN ARE
 AVAILABLE IN 24 FT. STOCK
 LENGTHS. VISIT usalum.com FOR
 MORE INFORMATION

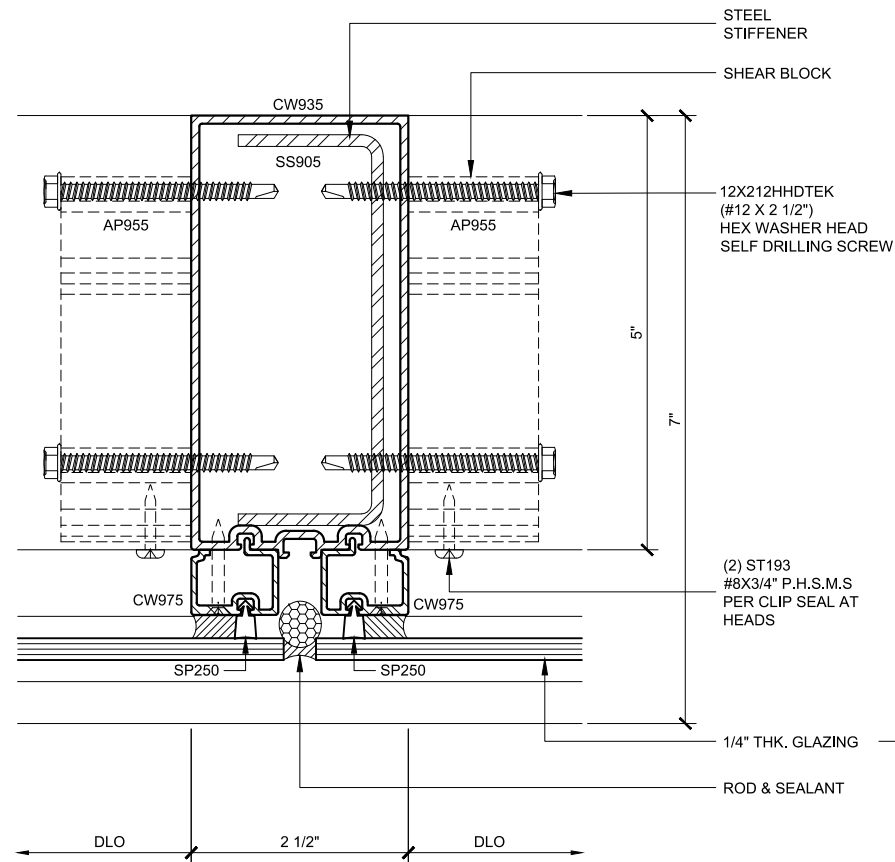

INT. VERT. PLAN (20)
 3252.3.4.20 (3252SG SERIES) 1'-0"=1'-0"
 SINGLE GLAZED
 5" BACK MEMBER
 TRANSITION DETAIL

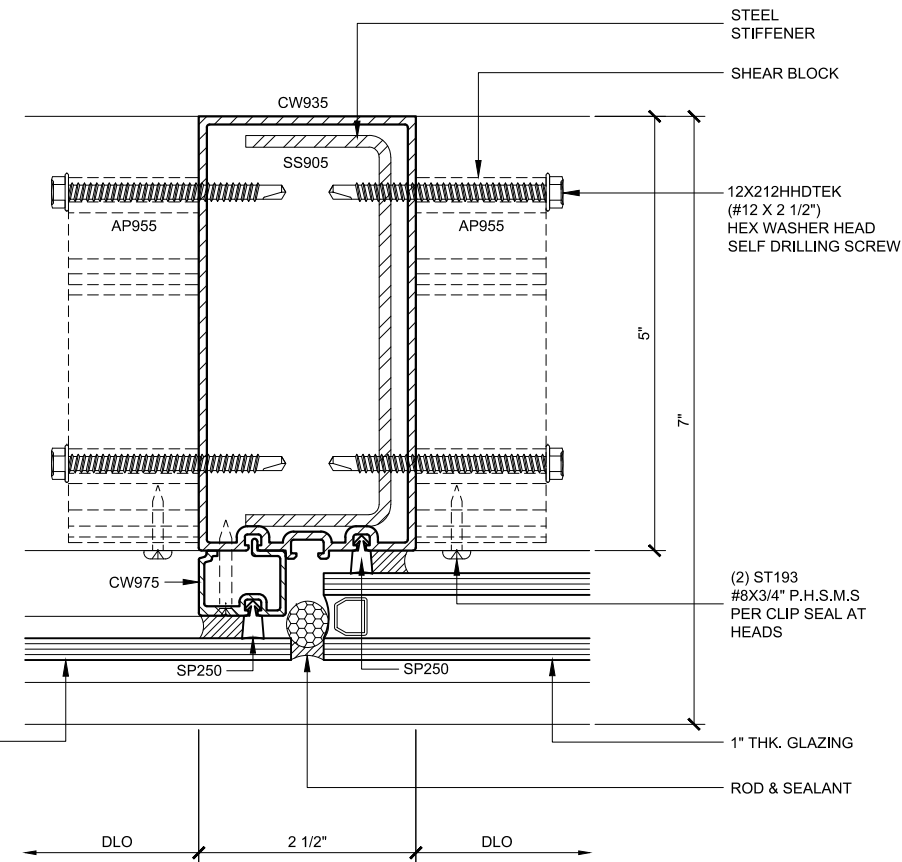

INT. VERT. PLAN (21)
 3152.3.4.21 (3252SG SERIES) 1'-0"=1'-0"
 SINGLE / DOUBLE GLAZED
 5" BACK MEMBER
 TRANSITION DETAIL

CURTAIN WALL SERIES 3252SG DETAILS

3252.3.4 - TRANSITION SINGLE / DOUBLE GLAZED - 5" BACK MEMBER

Revisions By:



C.R. LAURENCE CO. ARCHITECTURAL PRODUCTS
 2503 E. Vernon Avenue, Los Angeles, CA 90058-1897
 PH (800)-421-6144 FX: 800-587-7501 www.crlaurence.com

Description:
 U.S. ALUMINUM SERIES 3252
 & 3252SG CURTAIN WALL
 HIGH PERFORMANCE
 THERMALLY BROKEN

Drawn By: RPD
 Date: 12/01/14
 Scale: AS NOTED
 File Name: 3252.dwg
 Sheet

3252.3.4

U.S. ALUMINUM CURTAIN WALL SERIES 3252 SYSTEM

STANDARD ABBREVIATIONS	
RO	ROUGH OPENING
FD	FRAME DIMENSION
DLO	DAYLITE OPENING
DO	DOOR OPENING
DD	DOOR DIMENSION
SMC	SURFACE MOUNTED CLOSER
OHCC	OVERHEAD CONCEALED CLOSER

Revisions By:

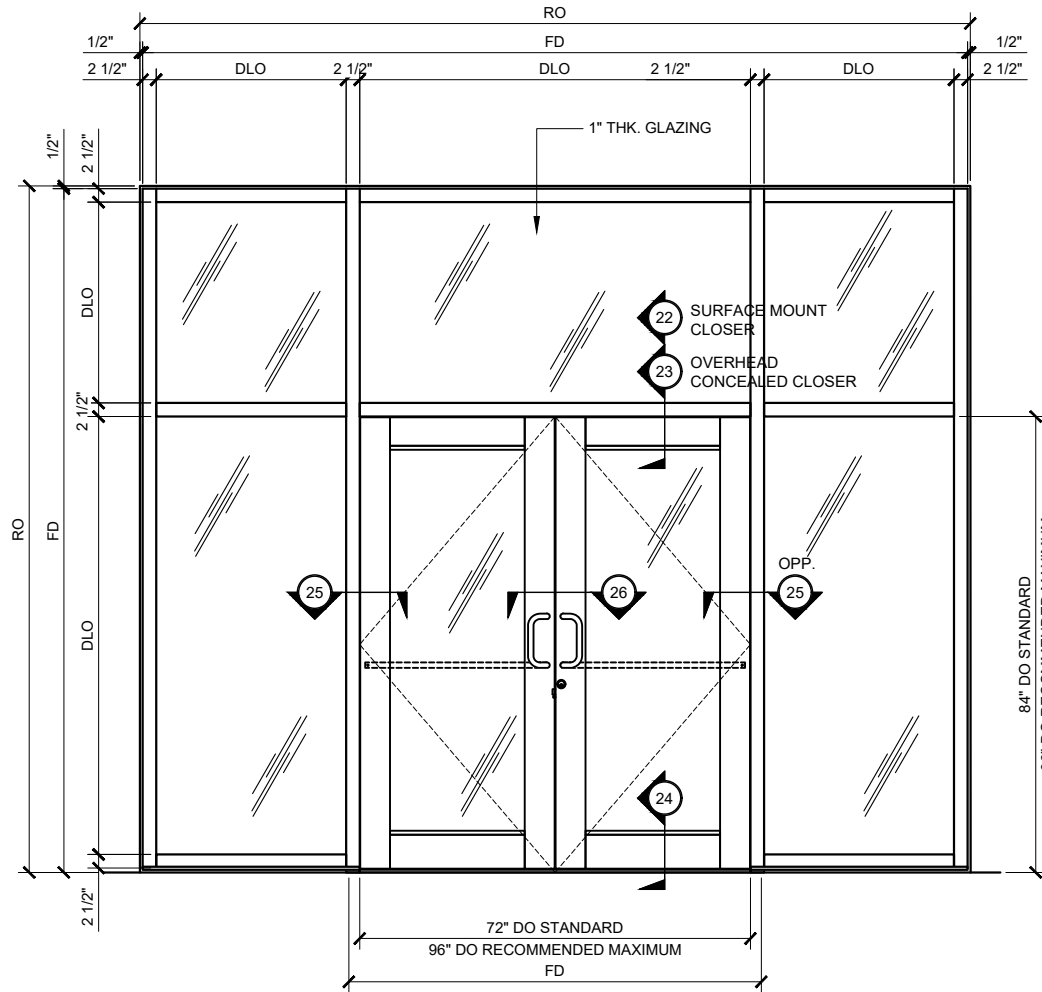

TYP. ELEVATION: THERMAL ENTRANCE WITH FLUSH DOOR ADAPTOR 3/4" = 1'-0"
1" THICK DOUBLE GLAZED
5" BACK MEMBER

SECTION
3/4" = 1'-0"

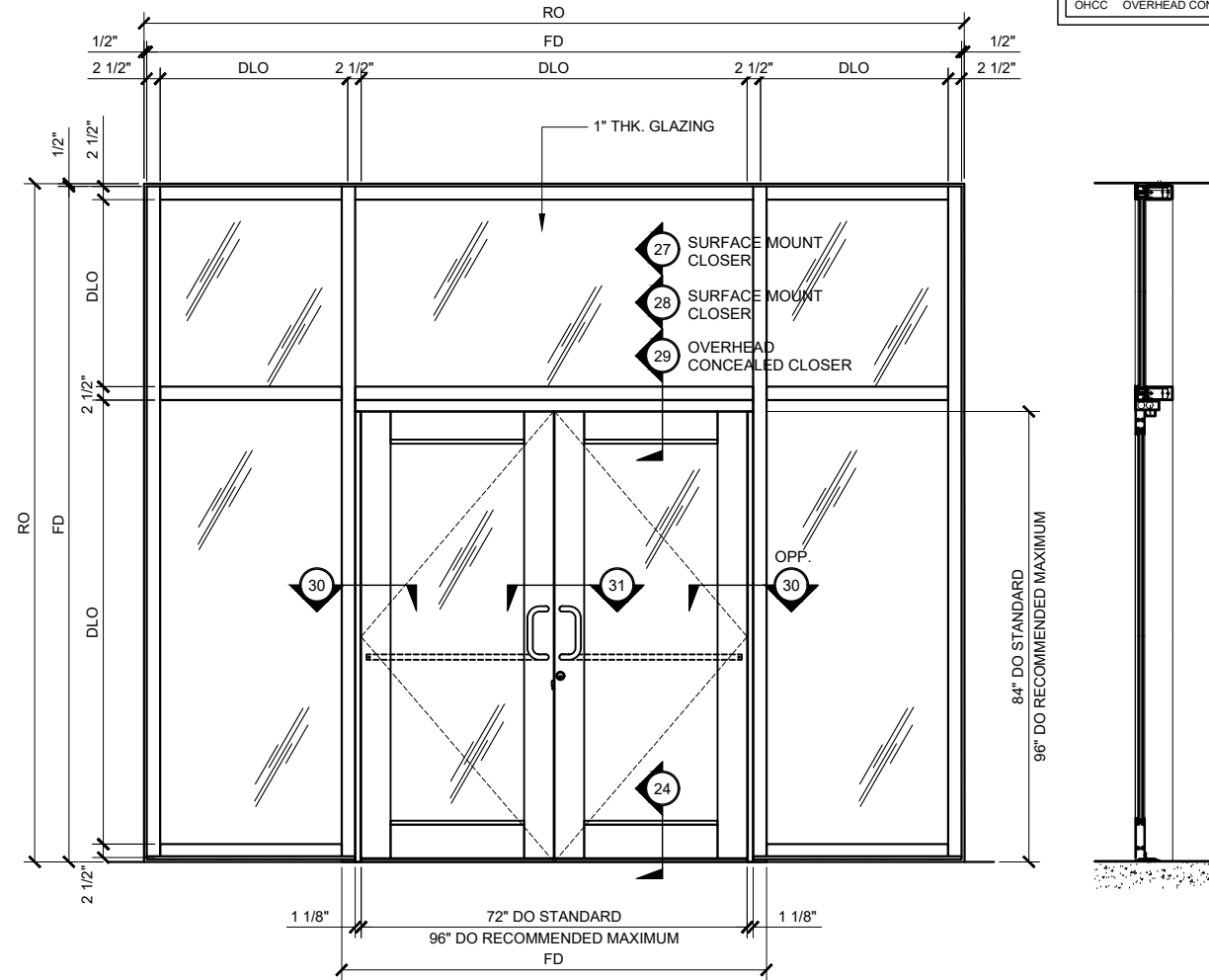

TYP. ELEVATION: THERMAL ENTRANCE WITH SUB-FRAME 3/4" = 1'-0"
1" THICK DOUBLE GLAZED
5" BACK MEMBER

SECTION
3/4" = 1'-0"

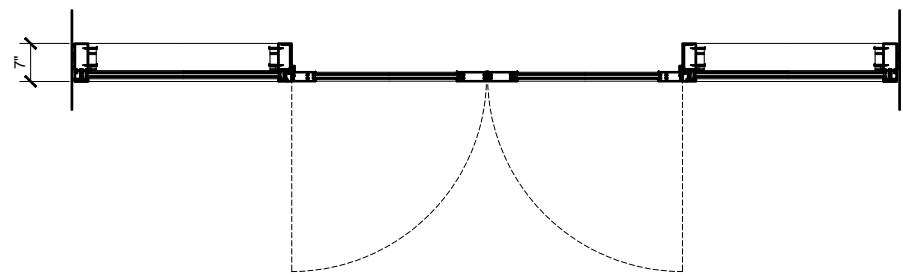

TYP. PLAN: THERMAL ENTRANCE WITH FLUSH DOOR ADAPTOR 3/4" = 1'-0"
1" THICK DOUBLE GLAZED
5" BACK MEMBER

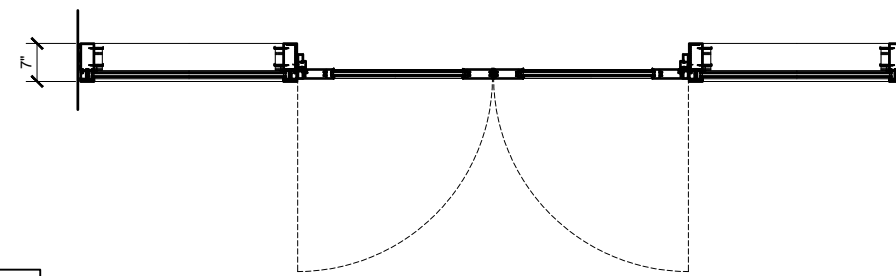

TYP. PLAN: THERMAL ENTRANCE WITH SUB-FRAME 3/4" = 1'-0"
1" THICK DOUBLE GLAZED
5" BACK MEMBER

NOTE:
1. SERIES 3252 CURTAIN WALL SHOWN WITH SERIES 400-T MEDIUM STILE THERMAL ENTRANCE DOOR
2. SERIES 400-T MEDIUM STILE AND 550-T WIDE STILE THERMAL ENTRANCES ARE STANDARD. SERIES 250, AND 550 NON-THERMAL ENTRANCES AVAILABLE ON REQUEST

ALUMINUM
C.R.LAURENCE CO. ARCHITECTURAL PRODUCTS
2503 E. Vernon Avenue, Los Angeles, CA 90058-1897
PH (800)-421-6144 FX: 800-587-7501 www.crlaurence.com

Description:
U.S. ALUMINUM SERIES 3252 & 3252SG CURTAIN WALL
HIGH PERFORMANCE THERMALLY BROKEN

Drawn By: RPD
Date: 12/01/14
Scale: AS NOTED
File Name: 3252.dwg

CURTAIN WALL SERIES 3252 TYPICAL ELEVATIONS

3252.4.1 HIGH PERFORMANCE - THERMALLY BROKEN - CAPTURED VERTICAL GLAZED CURTAIN WALL

Sheet
3252.4.1

U.S. ALUMINUM CURTAIN WALL SERIES 3252 SYSTEM

Revisions By:

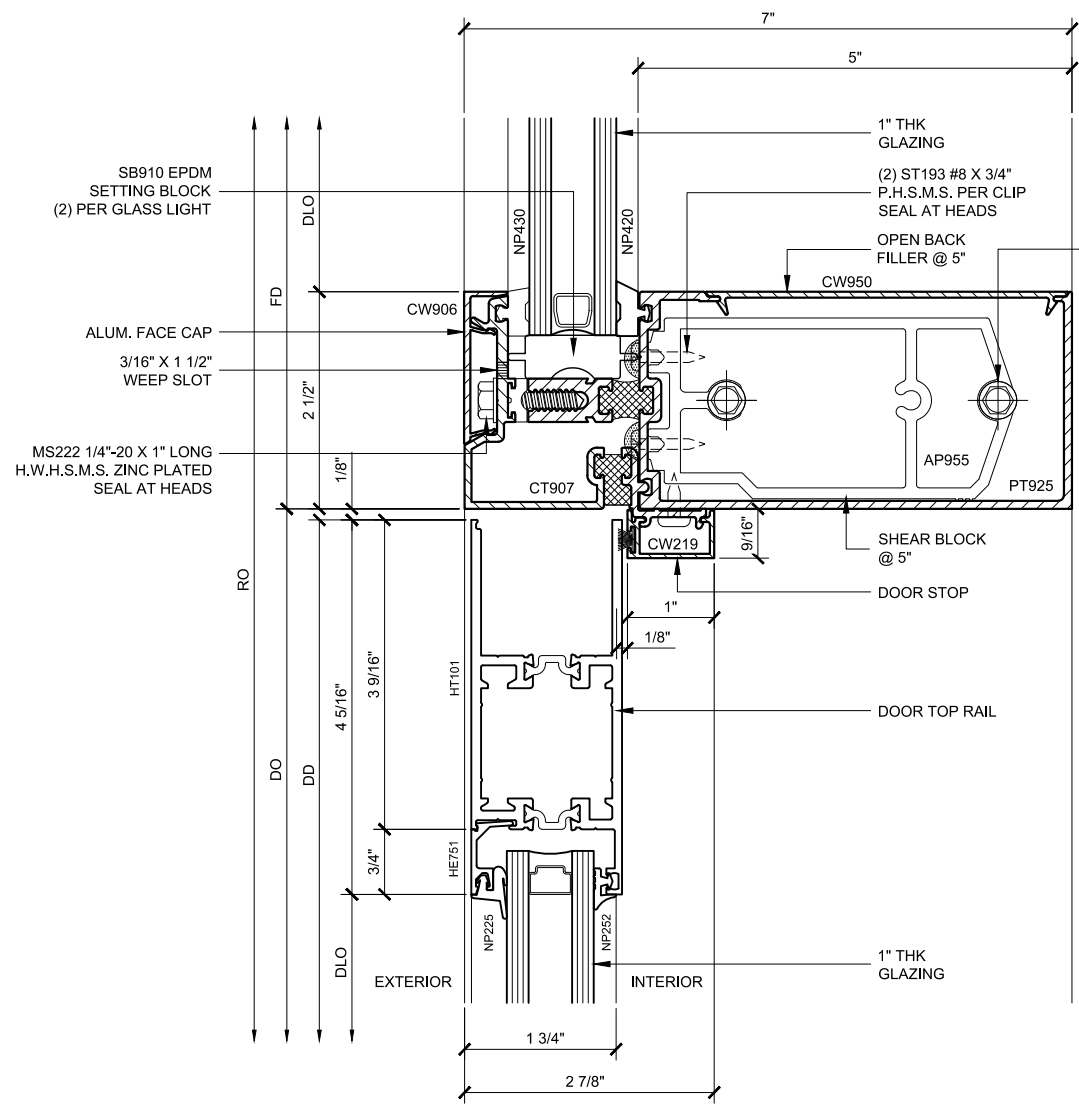
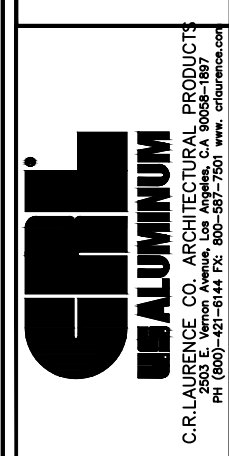

HEAD SECTION w/ SURFACE MOUNT CLOSER 22

3252.4.2.22
DOUBLE GLAZED
5" BACK MEMBER

SCALE: FULL SIZE

NOTES:
1. 5" OPEN BACK AND TUBULAR HORIZONTALS SHOWN. OTHER DEPTH OPEN BACK HORIZONTALS AND TUBULAR HORIZONTALS ARE SIMILAR.
2. SERIES 400-T MEDIUM STILE AND 550-T WIDE STILE THERMAL ENTRANCES ARE STANDARD. SERIES 250, 400 AND 550 NON-THERMAL ENTRANCES ARE AVAILABLE ON REQUEST.

12X212HHDTEK (#12 X 2 1/2") HEX WASHER HEAD SELF DRILLING SCREW

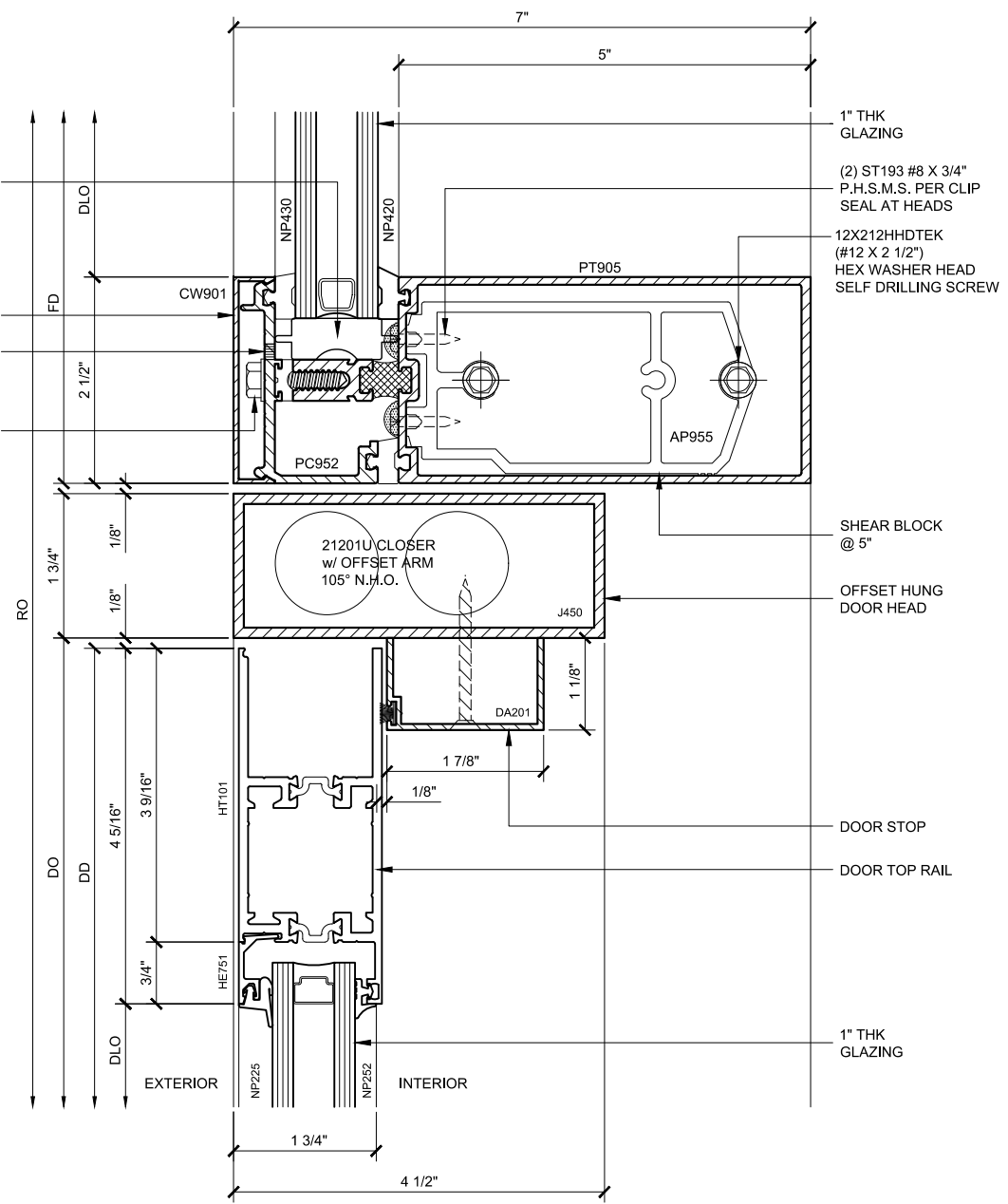

HEAD SECTION w/ OHCC 23

3252.4.2.23
DOUBLE GLAZED
5" BACK MEMBER

SCALE: FULL SIZE

CURTAIN WALL SERIES 3252 DETAILS

3252.4.2 - THERMAL ENTRANCE WITH FLUSH DOOR ADAPTOR

Description:
U.S. ALUMINUM SERIES 3252 & 3252SG CURTAIN WALL
HIGH PERFORMANCE THERMALLY BROKEN

Drawn By: RPD
Date: 12/01/14
Scale: AS NOTED
File Name: 3252.dwg
Sheet

3252.4.2

U.S. ALUMINUM CURTAIN WALL SERIES 3252 SYSTEM

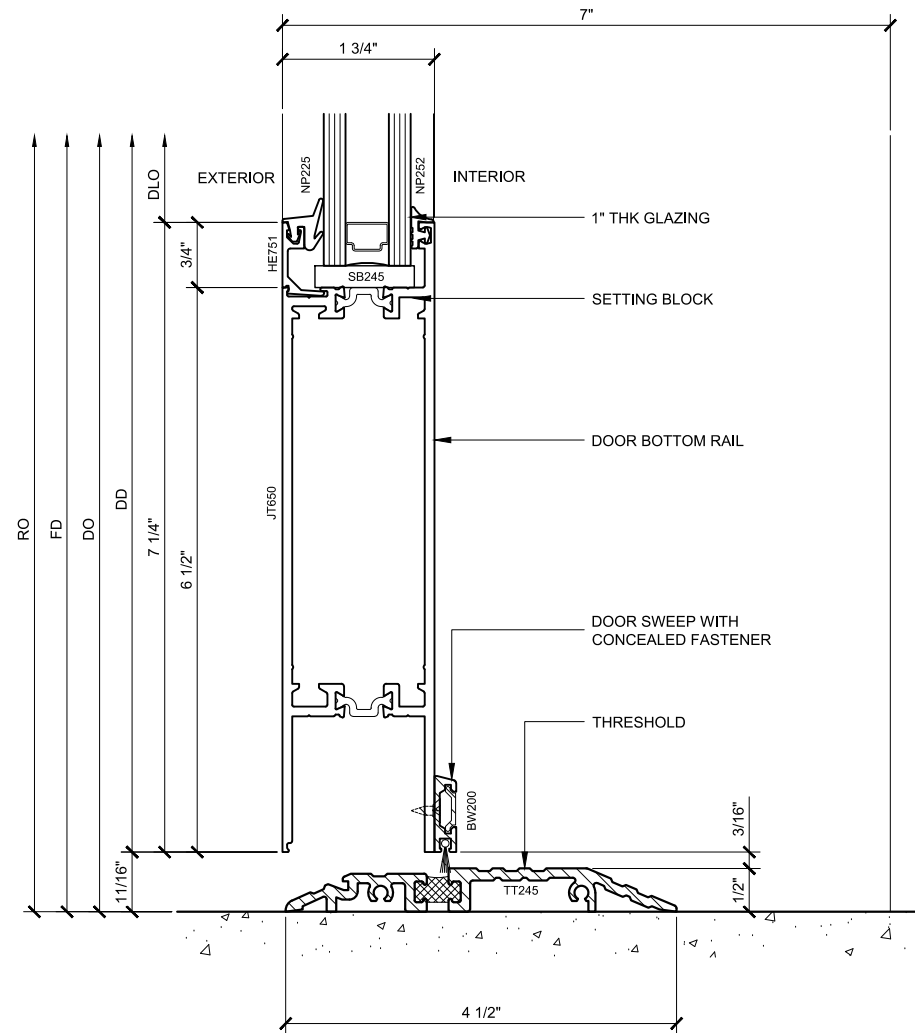

SECTION DETAIL @ 7" DOOR SILL (24)
 3252.4.3.24
 DOUBLE GLAZED
 5" BACK MEMBER
 SCALE: FULL SIZE

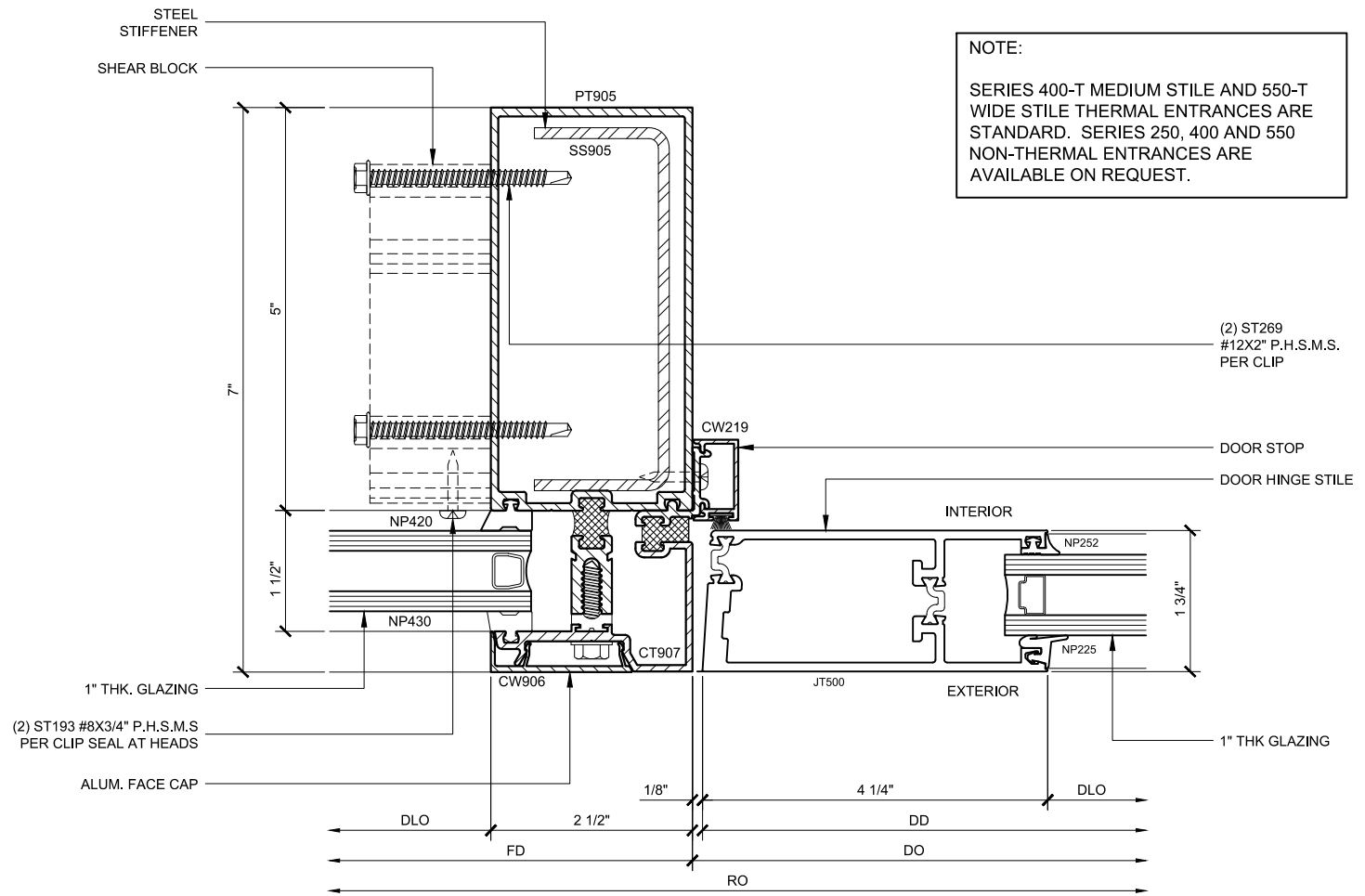

SECTION DETAIL @ DOOR JAMB (25)
 3252.4.3.25
 DOUBLE GLAZED
 5" BACK MEMBER
 SCALE: FULL SIZE

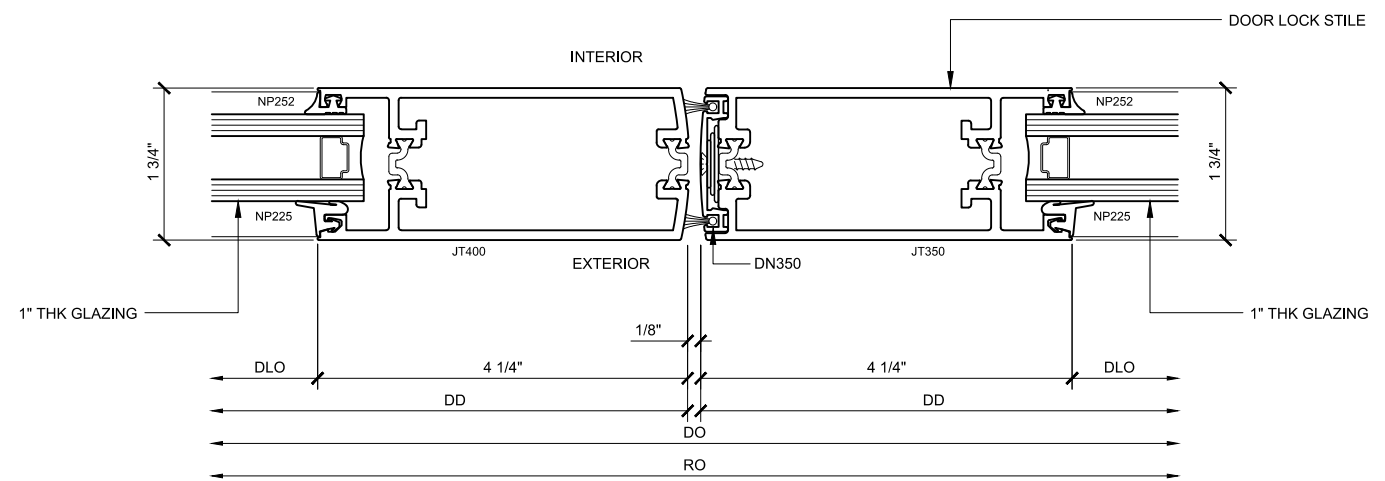

SECTION DETAIL @ MEETING STILES (26)
 3252.4.3.26
 DOUBLE GLAZED
 SCALE: FULL SIZE

NOTE:
 SERIES 400-T MEDIUM STILE AND 550-T WIDE STILE THERMAL ENTRANCES ARE STANDARD. SERIES 250, 400 AND 550 NON-THERMAL ENTRANCES ARE AVAILABLE ON REQUEST.

Revisions By:

C.R. LAURENCE CO. ARCHITECTURAL PRODUCTS
 2503 E. Vernon Avenue, Los Angeles, CA 90058-1897
 PH (800)-421-6144 FX: 800-587-7501 www.crlaurence.com

Description:
 U.S. ALUMINUM SERIES 3252
 & 3252SG CURTAIN WALL
 HIGH PERFORMANCE
 THERMALLY BROKEN

Drawn By: RPD
 Date: 12/01/14
 Scale: AS NOTED
 File Name: 3252.dwg
 Sheet

CURTAIN WALL SERIES 3252 DETAILS
 3252.4.3 - THERMAL ENTRANCE WITH FLUSH DOOR ADAPTOR

3252.4.3

U.S. ALUMINUM CURTAIN WALL SERIES 3252 SYSTEM

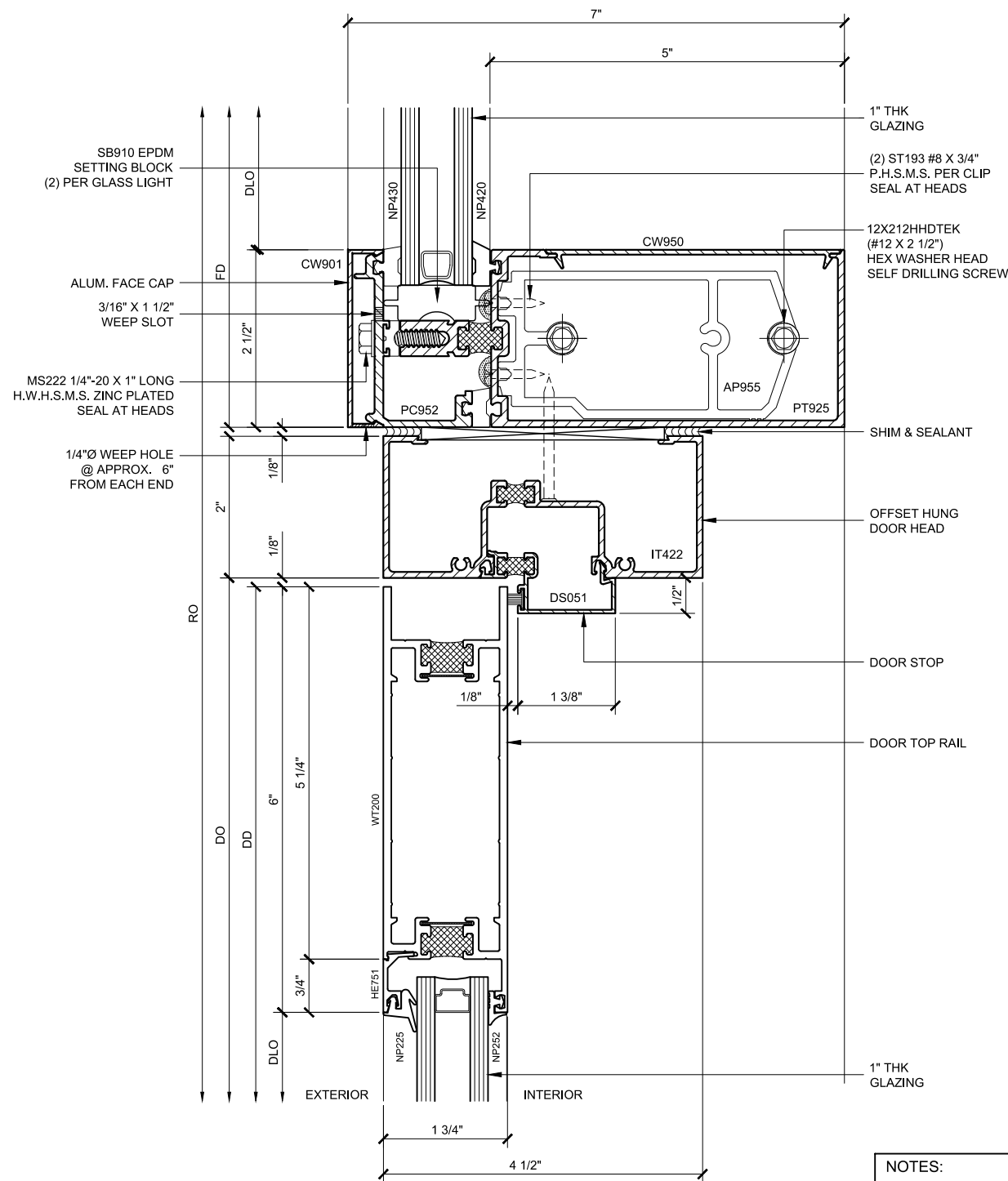

HEAD SECTION w/ SUB-FRAME (27)

3252.4.4.27
DOUBLE GLAZED
5" BACK MEMBER

SCALE: FULL SIZE

NOTES:

1. 5" OPEN BACK AND TUBULAR HORIZONTALS SHOWN. OTHER DEPTH OPEN BACK HORIZONTALS AND TUBULAR HORIZONTALS ARE SIMILAR.
2. SERIES 400-T MEDIUM STILE AND 550-T WIDE STILE THERMAL ENTRANCES ARE STANDARD. SERIES 250, 400 AND 550 NON-THERMAL ENTRANCES ARE AVAILABLE ON REQUEST.

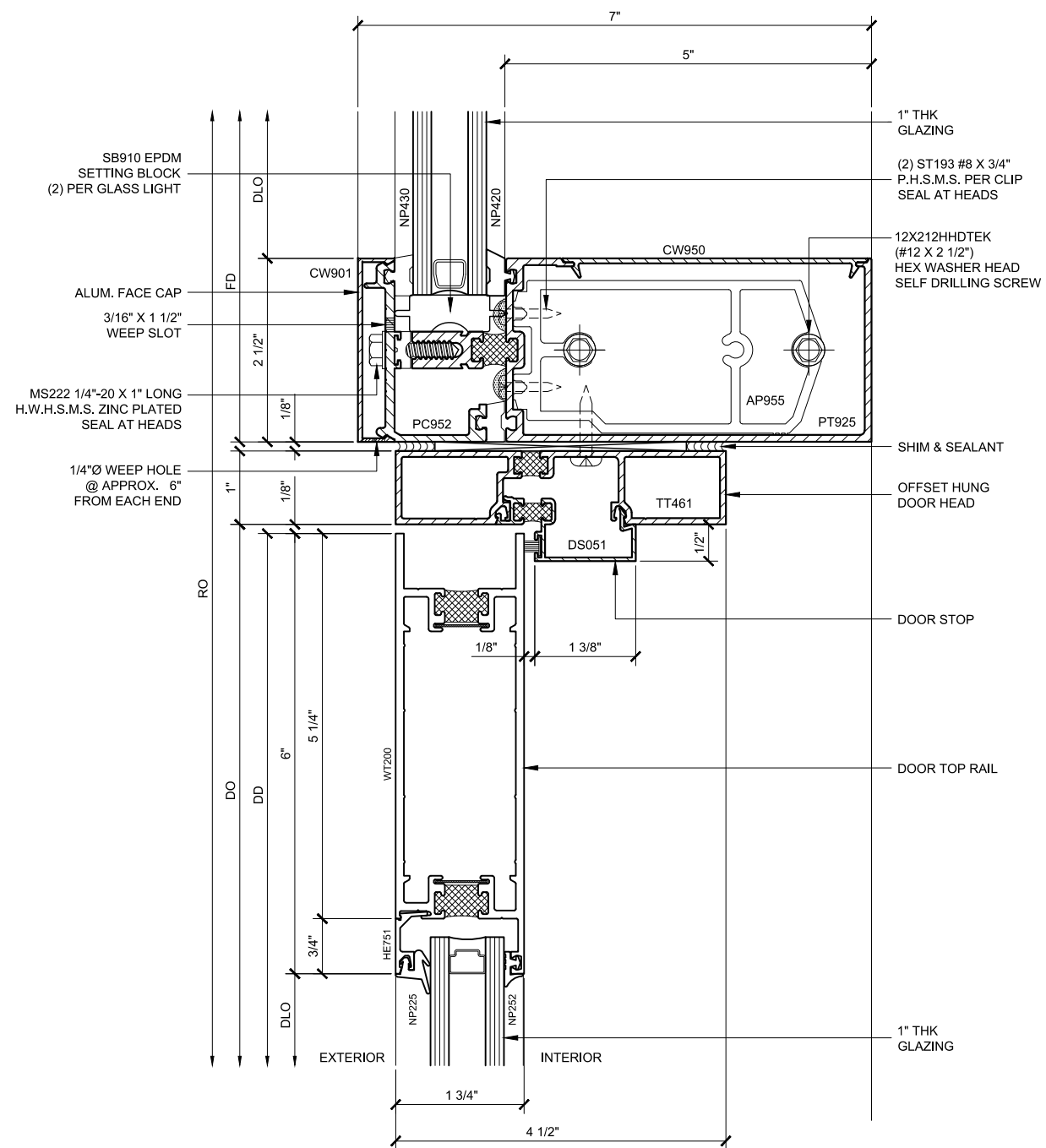

HEAD SECTION w/ SUB-FRAME (28)

3252.4.4.28
DOUBLE GLAZED
5" BACK MEMBER

SCALE: FULL SIZE

CURTAIN WALL SERIES 3252 DETAILS

3252.4.4 - THERMAL ENTRANCE WITH SUB-FRAME

Revisions By:



C.R. LAURENCE CO. ARCHITECTURAL PRODUCTS
2503 E. Vernon Avenue, Los Angeles, CA 90058-1897
PH (800)-421-6144 FX: 800-587-7501 www.crlaurence.com

Description:
U.S. ALUMINUM SERIES 3252
& 3252SG CURTAIN WALL
HIGH PERFORMANCE
THERMALLY BROKEN

Drawn By: RPD

Date: 12/01/14

Scale: AS NOTED

File Name: 3252.dwg

Sheet

3252.4.4

U.S. ALUMINUM CURTAIN WALL SERIES 3252 SYSTEM

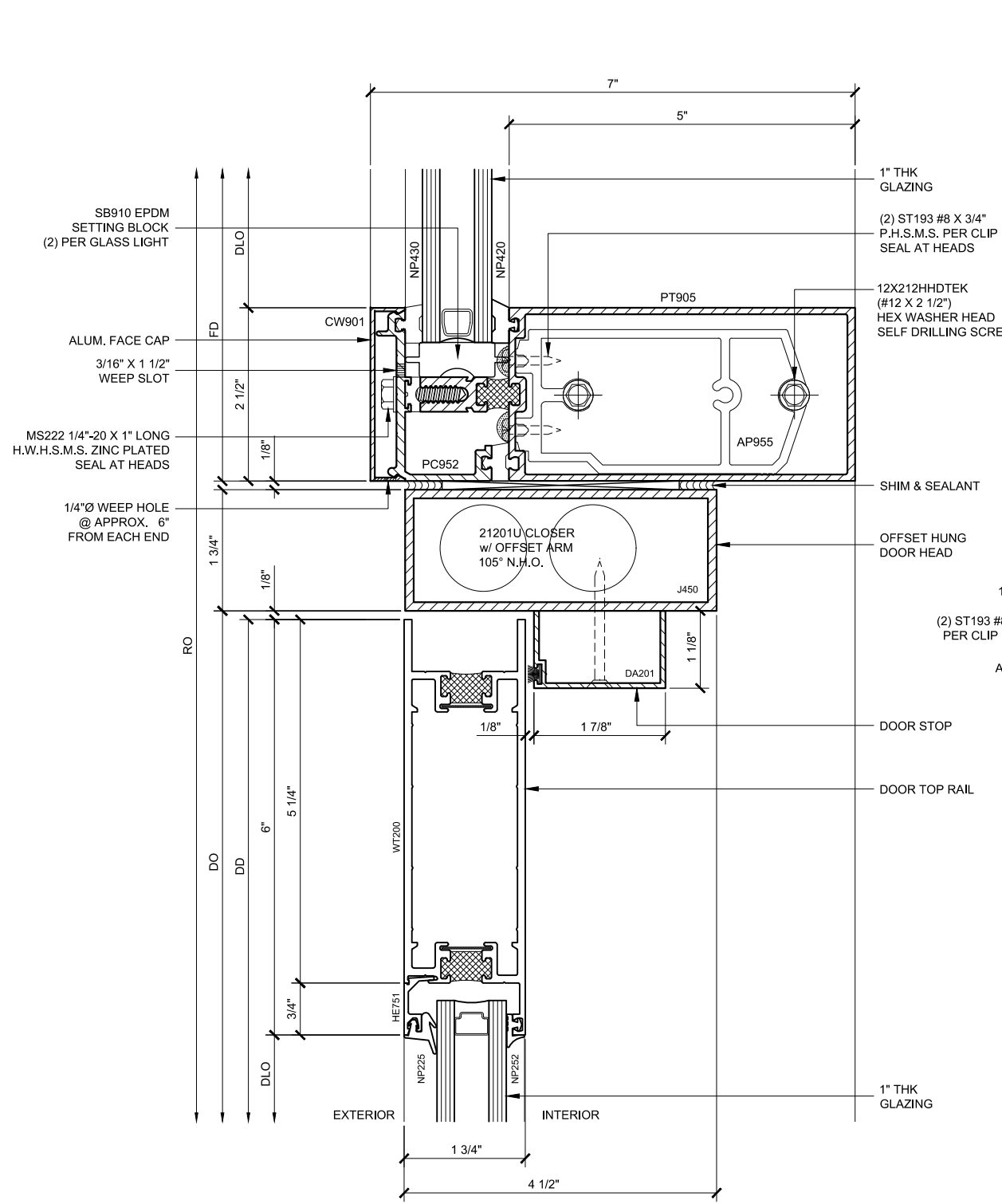

HEAD SECTION w/ OHCC (29)
 3252.4.5.29
 DOUBLE GLAZED
 5\"/>

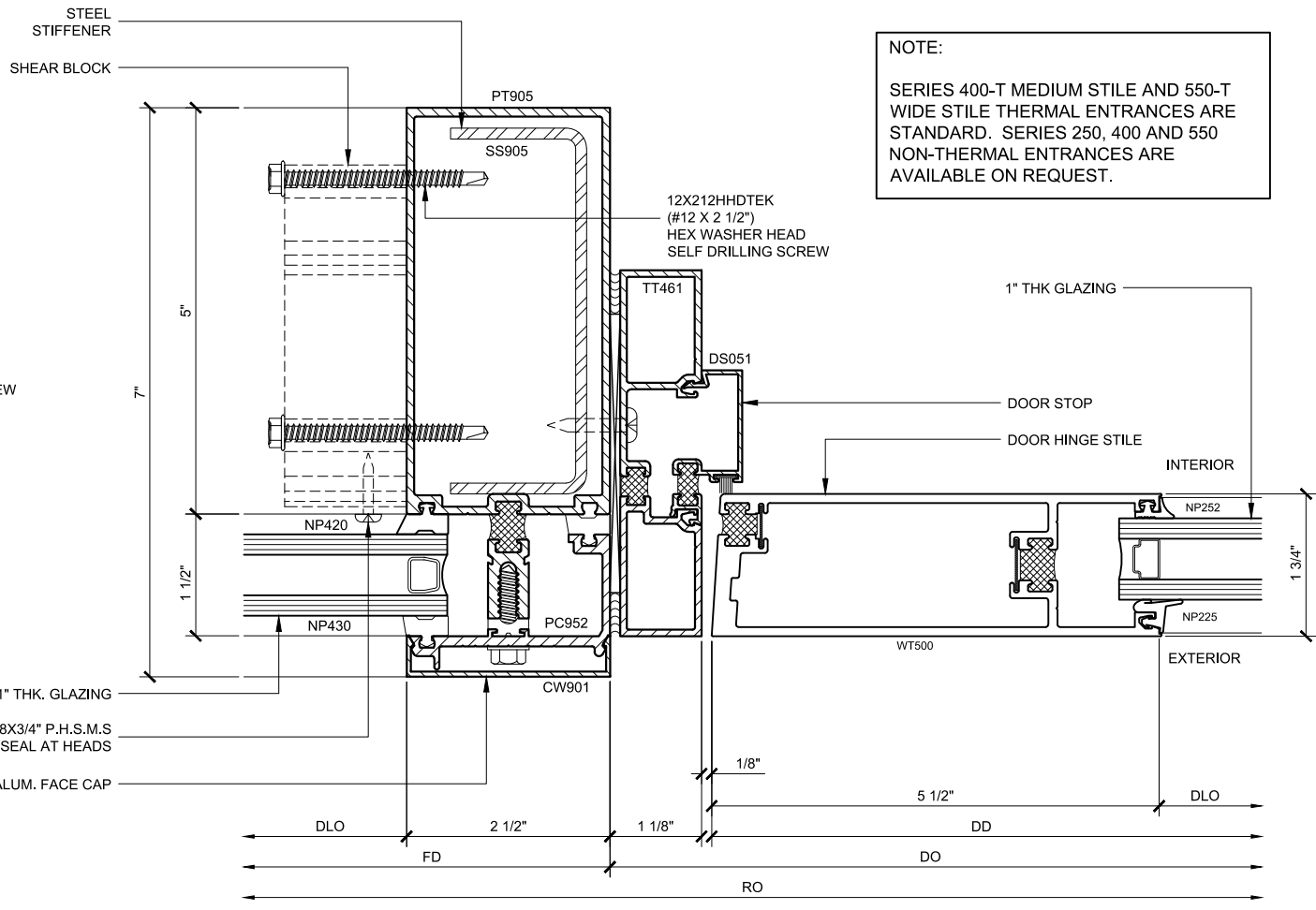

SECTION DETAIL @ DOOR JAMB (30)
 3252.4.5.30
 DOUBLE GLAZED
 5\"/>

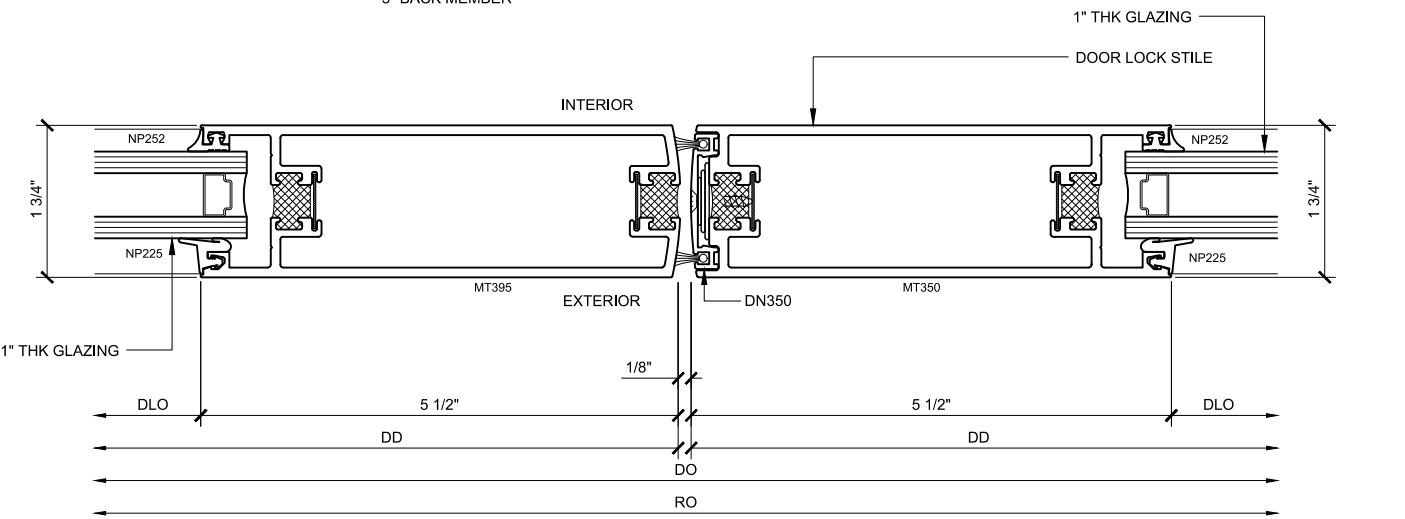

SECTION DETAIL @ MEETING STILES (31)
 3252.4.5.31
 DOUBLE GLAZED
 SCALE: FULL SIZE

NOTE:
 SERIES 400-T MEDIUM STILE AND 550-T WIDE STILE THERMAL ENTRANCES ARE STANDARD. SERIES 250, 400 AND 550 NON-THERMAL ENTRANCES ARE AVAILABLE ON REQUEST.

CURTAIN WALL SERIES 3252 DETAILS

3252.4.5 - THERMAL ENTRANCE WITH SUB-FRAME

Revisions By:



C.R. LAURENCE CO. ARCHITECTURAL PRODUCTS
 2503 E. Vernon Avenue, Los Angeles, CA 90058-1897
 PH (800)-421-6144 FX: 800-587-7501 www.crlaurence.com

Description:
 U.S. ALUMINUM SERIES 3252
 & 3252SG CURTAIN WALL
 HIGH PERFORMANCE
 THERMALLY BROKEN

Drawn By: RPD
 Date: 12/01/14
 Scale: AS NOTED
 File Name: 3252.dwg

Sheet
 3252.4.5