



Glazing, Industrial, Construction  
and Automotive Supplies  
Phone Toll Free (800)421-6144  
Fax Toll Free (800)262-3299

Locations to Serve the Industries Throughout North America & Europe  
Corp. Headquarters: P.O. Box 58923, Los Angeles, CA 90058-0923  
Website Address: www.crlsource.com

# PR70

## PULL SIDE DOOR MOUNTED

SELECT THE PICTURE THAT MATCHES YOUR INSTALLATION AND FOLLOW DIRECTIONS ON THAT SIDE OF PAGE.

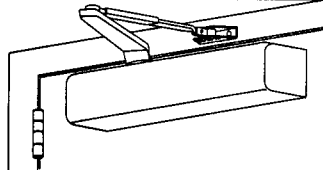

### CAUTION

IMPROPER INSTALLATION OR  
REGULATION MAY RESULT IN  
PERSONAL INJURY OR  
PROPERTY DAMAGE. FOLLOW ALL  
INSTRUCTIONS CAREFULLY. FOR  
QUESTIONS, CALL CRL AT  
800-421-6144

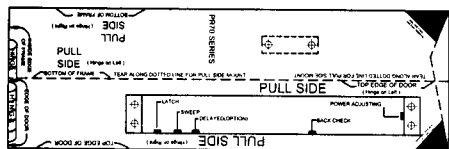
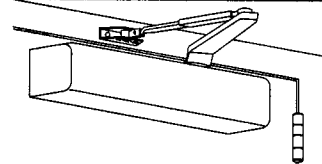

1 LOCATE PULL SIDE TEMPLATES  
& SEPARATE ON DOTTED LINE.

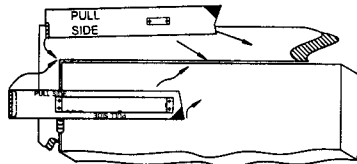
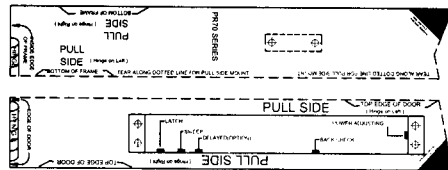

2 PEEL OFF TEMPLATES AND ALIGN WITH HINGE EDGE  
OF DOOR & FRAME. CENTER PUNCH TEMPLATE HOLES.

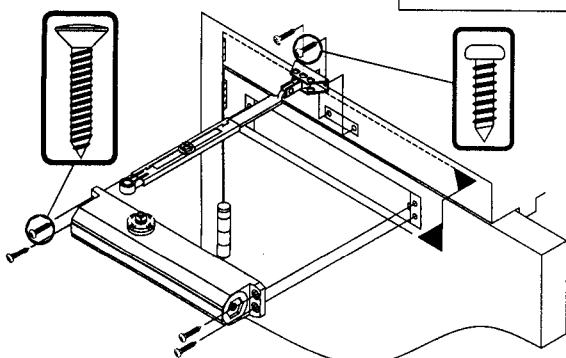
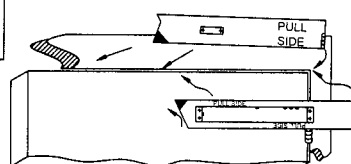

3 PEEL TEMPLATES OFF OF DOOR & FRAME.  
ATTACH MOUNTING BODY, ROD & SHOE.

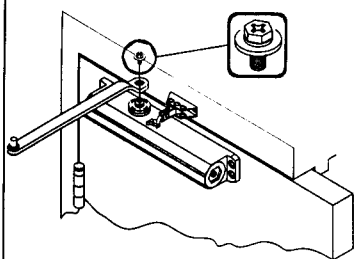
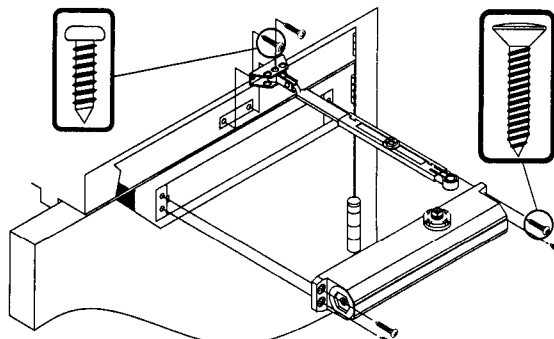

4 ATTACH MAIN ARM TO CLOSER. CONNECT ARM WITH  
ROD & SHOE. PRELOAD ARM TO 90° AS SHOWN.

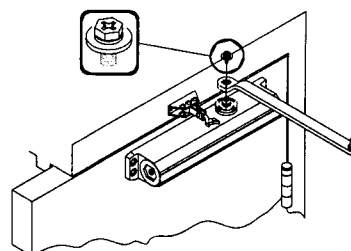
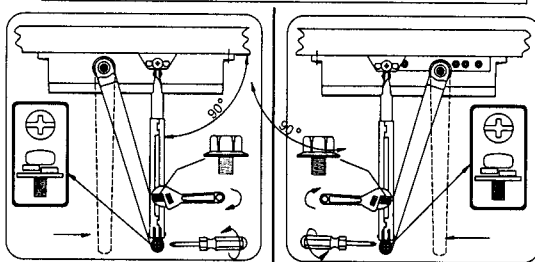

IF NECESSARY, ADJUST SPRING POWER (FACTORY SET AT 3) AND DOOR SPEEDS.

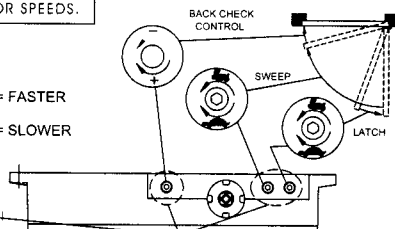
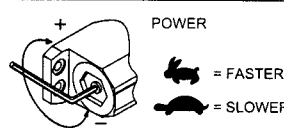
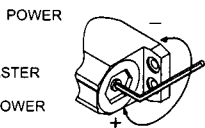
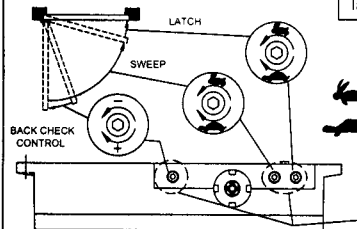

### CAUTION

DO NOT TURN ADJUSTING VALVES MORE  
THAN 2 FULL TURNS COUNTER-CLOCKWISE  
FROM THE FACTORY SET POSITIONS.

### ATTACH FULL COVER

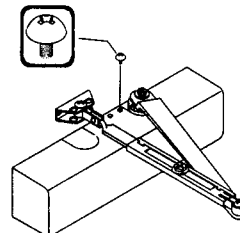
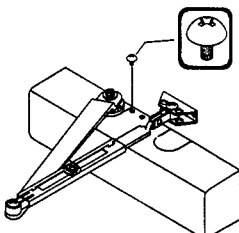

DOOR CLOSER SIZE	CLOCKWISE TURNS OF ADJUSTING NUT		APPLICABLE DOOR SIZE		APPLICABLE DOOR WEIGHT
	PR70 (SIZE 1/2-4)	PR72 (SIZE 2-6)	INTERIOR	EXTERIOR (SWING OUT)	
1/2	NOT RECOMMENDED USE PR70-MGN	-9	N/A	28"(0.71m)	22-33 Lbs (10-15Kg)
1	NOT RECOMMENDED USE PR70-MGN	-6	N/A	32"(0.81m)	33-66 Lbs (15-30Kg)
2	2	-3	-3	38"(0.91m)	66-99 Lbs (30-45Kg)
3	3	0 (FACTORY SET)	0 (FACTORY SET)	42"(1.07m)	89-143 Lbs (40-65Kg)
4	4	3	6	48"(1.22m)	143-187 Lbs (65-85Kg)
NOT RECOMMENDED USE PR70-MGN	5	N/A	9	54"(1.37m)	187-264 Lbs (85-120Kg)
NOT RECOMMENDED USE PR70-MGN	6	N/A	12	58"(1.47m)	264-330 Lbs (120-150Kg)

\*-3 MEANS 3 TURNS TO ANTI-CLOCKWISE