

CRL Dust Collector for DBS Machines



OPERATING INSTRUCTIONS

September 2012



crlaurence.com • CRL Glass Machinery

C. R. Laurence Co., Inc. • 2503 E. Vernon Ave., Los Angeles, California USA 90058 (323) 588-1281
CRL Glass Machinery • 5501 W. Ogden Ave., Cicero, Illinois USA 60804 (773) 242-2871









Operator Safety: Required Reading

IMPORTANT! Safety is the single most important consideration in the operation of this equipment. The following instructions must be followed at all times.

There are certain applications for which this tool was designed. We strongly recommend that this tool not be modified and/or used for any other application other than that for which it was designed. If you have any questions about its application, do not use the tool until you have contacted us and we have advised you.

General Safety Warnings

KNOW YOUR POWER TOOL. Read the owner's manual carefully. Learn the tool's applications, work capabilities, and its specific potential hazards.

 ⚠ DANGER	ALWAYS GROUND ALL TOOLS. If your tool is equipped with a three-pronged plug, you must plug it into a three-hole electric receptacle. If you use an adapter to accommodate a two-pronged receptacle, you must attach the adapter plug to a known ground. Never remove the third prong of the plug. ALWAYS AVOID DANGEROUS ENVIRONMENTS. Never use power tools in damp or wet locations. Keep your work area well lighted and clear of clutter.
 ⚠ DANGER	ALWAYS REMOVE THE ADJUSTING KEYS AND WRENCHES FROM TOOLS AFTER USE. Form the habit of checking to see that keys and adjusting wrenches are removed from the tool before turning it on. ALWAYS KEEP YOUR WORK AREA CLEAN. Cluttered areas and benches invite accidents.
 ⚠ DANGER	ALWAYS KEEP VISITORS AWAY FROM RUNNING MACHINES. All visitors should be kept a safe distance from the work area. ALWAYS MAKE THE WORKSHOP CHILDPROOF. Childproof with padlocks, master switches, or by removing starter keys.
 ⚠ DANGER	NEVER OPERATE A TOOL WHILE UNDER THE INFLUENCE OF DRUGS, MEDICATION, OR ALCOHOL.
 ⚠ DANGER	ALWAYS WEAR PROPER APPAREL. Never wear loose clothing or jewelry that might get caught in moving parts. Rubber-soled footwear is recommended for the best footing.
 ⚠ DANGER	ALWAYS USE SAFETY GLASSES AND WEAR HEARING PROTECTION. Also use a face or dust mask if the cutting operation is dusty.
 ⚠ DANGER	NEVER OVERREACH. Keep your proper footing and balance at all times.
 ⚠ DANGER	NEVER STAND ON TOOLS. Serious injury could occur if the tool is tipped or if the cutting tool is accidentally contacted.

⚠ DANGER**ALWAYS DISCONNECT TOOLS.**

Disconnect tools before servicing and when changing accessories such as blades, bits, and cutters.

**ALWAYS AVOID ACCIDENTAL STARTING.**

Make sure switch is in “OFF” position before plugging in cord.

NEVER LEAVE TOOLS RUNNING UNATTENDED.**⚠ DANGER****ALWAYS CHECK FOR DAMAGED PARTS.**

Before initial or continual use of the tool, a guard or other part that is damaged should be checked to assure that it will operate properly and perform its intended function. Check for alignment of moving parts, binding of moving parts, breakage of parts, mounting, and any other conditions that may affect its operation. A guard or other damaged parts should immediately be properly repaired or replaced.



Special Safety Rules For Dust Collectors

1. Do not operate this machine until you have read all of the following instructions.
2. Do not attempt to operate this machine until it is completely assembled.
3. Do not turn ON this machine if any pieces are missing.
4. If you are not familiar with the operation of the machine, obtain assistance from a qualified person.
5. It is highly recommended that this machine be placed on a level surface.
6. Always wear protective eyewear prior to operating this machine.
7. Do not operate this machine if you are under the influence of drugs and/or alcohol.
8. Remove all jewelry prior to operating this machine.
9. Do not wear any gloves while operating this machine.
10. Always make sure the power switch is in the OFF position prior to plugging in the machine.
11. Always make sure the power switch is in the OFF position when doing any assembly or setup operation.
12. Always wear a dust mask when cleaning or working near a dust collector.
13. The use of any accessories or attachments not recommended may cause injury to you and damage your machine.
14. This machine must be properly grounded.
15. Always keep your face and hands clear of moving parts such as impellers and fans.
16. Keep these instructions for future reference.

California Proposition 65 Warning

WARNING: Some dust created by power sanding, sawing, grinding, drilling, and other construction activities contains chemicals known to the State of California to cause cancer and birth defects or other reproductive harm. Your risk from exposure to these chemicals varies, depending on how often you do this type of work. To reduce your exposure, work in a well-ventilated area and with approved safety equipment, such as dust masks that are specially designed to filter out microscopic particles.

**SAVE THESE INSTRUCTIONS.
Refer to them often.**

Table of Contents

Safety Warnings.....	2-3
Dust Collector Safety Rules	3
Specifications	4
Contents of Package	5
Assembly	6-8
Dust Hazards and Safety.....	9
Electrical Requirements	10
Trouble Shooting.....	11
Wiring Diagram.....	11
Parts List	12
Parts Explosion.....	13
Warranty	14
Notes.....	15

Specifications

Model #	60-200
Cubic Feet Per Min	1250 CFM
Motor	2HP, 208/230/480V -3PH, 6/3A*
Motor Speed	3600RPM
Blower Wheel Diameter	12"
Sound Rating @ 3 ft.	<78dB
Bag Filtration	1 Micron
Bag Diameter	20"
Bag Capacity	5.4 Cu.Ft.
Bag Length	33"
Hose Connection	1@5", 2@4"
Overall Dimensions	37"(L) x 22"(W) x 76-1/2"(H)
Net Weight	104 lbs

* Service 10A, SCCR 5KA

Contents of Package

When unpacking, check to make sure the following parts are included. If any parts are missing or broken, please call USA@T&C at the number on the cover of this manual as soon as possible.

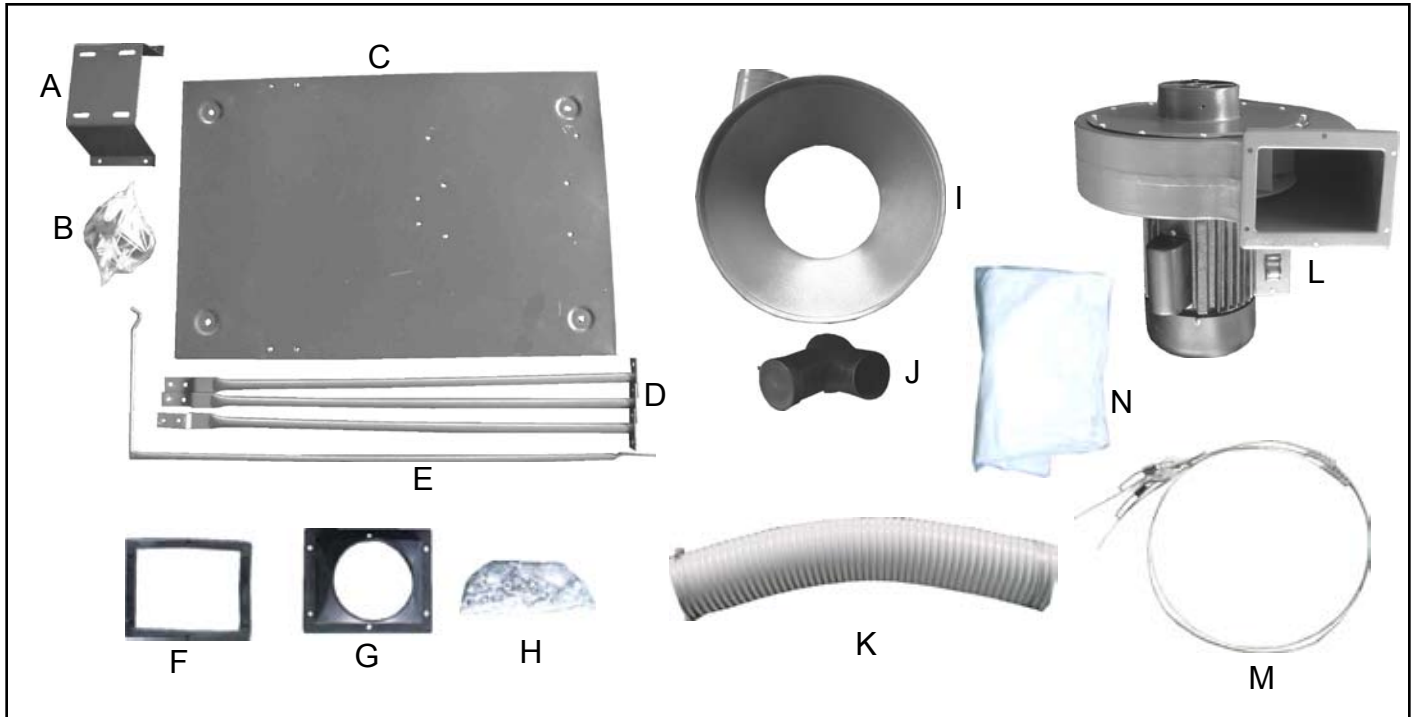

- | | | | |
|---|--------------------|---|-----------------------|
| A | Motor base | H | Bag of loose parts |
| B | Bag of casters | I | Collector |
| C | Base plate | J | "Y" Inlet |
| D | Collector supports | K | 5" Hose & hose clamps |
| E | Upper bag support | L | Fan housing & motor |
| F | Rubber gasket | M | Strap |
| G | 5" Outlet | N | Filter bags |

Assembly

Installing Casters to Base Plate

Locate the four swivel casters, four 12MM hex nuts and four 12MM hex cap nuts from hardware pack.

1. Insert the threaded stud from swivel caster through one of the four holes in the corner of the base plate.
2. Place 12MM hex nut and 12MM hex cap nut onto threaded stud of swivel caster and tighten (Fig. 01).
3. Repeat steps 1 and 2 for the remaining three swivel caster assemblies.



Fig. 01

Attaching Motor Base to Base Plate

Locate the motor base, four M8X16MM hex bolts and four 8MM washers.

1. Lay the motor base onto the base plate. Align the holes in the motor base with the holes in the base plate.
2. Place a washer over a hex bolt and insert through the motor base into the the threaded hole in the base plate and tighten (Fig. 02).
3. Repeat steps 1 and 2 for the remaining three hex bolts.

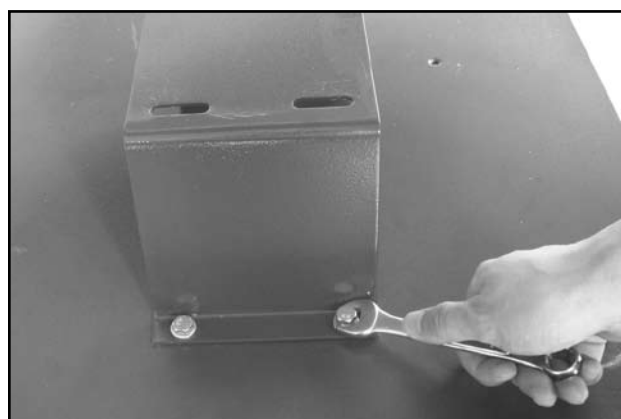

Fig. 02

Mounting Fan Housing & Motor to Base

Locate the fan housing and motor, Four M8X20MM hex bolts and four 8MM washers.

1. Place the fan housing & motor onto the motor base . Align the holes in the fan housing and motor with the holes in the motor base.
2. Install a hex bolt through the holes on the motor base and motor from underside of motor base, place a washer and a hex nut on the top to tighten the bolt. (A-Fig. 03).
3. Repeat step 2 for the remaining three mounting positions and tighten.
4. Install a washer over a hex bolt and insert through the strut in the fan housing into the the threaded hole in the base plate (B-Fig. 03). Repeat for second strut.

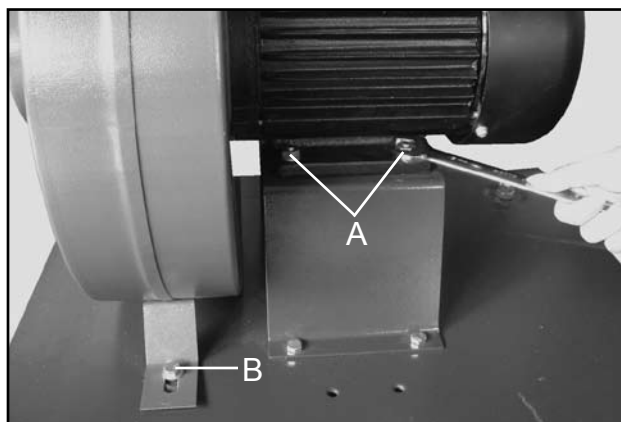

Fig. 03

Installing the 5" Outlet and Rubber Gasket

Locate the 5" plastic outlet, rubber gasket, six M6X20MM hex bolts and six 6MM washers.

1. Place the rubber gasket on the flange of the fan housing (A--Fig. 04).
2. Align the holes of the mounting flange on the fan housing for the holes of the 5" outlet (B--Fig. 04).
3. Secure the assembly with the six M6X20MM hex bolts and 6MM washers.

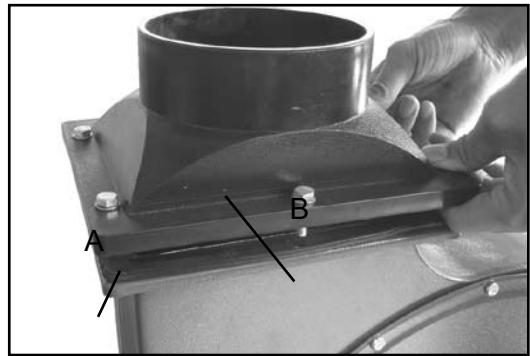

Fig. 04

Installing the Collector Supports

Locate the three collector support bars, six M8X15MM hex bolts and six 8MM washers.

1. Hold one collector support bar upright over the holes located near the caster mounting location as shown on the base.
2. Insert the hex bolts and washers through the collector support bar into the threaded holes in the base and tighten (Fig. 05).
3. Repeat for the remaining support bars.



Fig. 05

Installing the Collector & Upper Bag Support

Locate the collector, upper bag support, four M8X15MM hex bolts and four 8MM washers.

1. With assistance, hold the collector in position and align the front mounting holes.
2. Insert the hex bolts and washers through the collector support bar into the front threaded holes in the collector and tighten (Fig. 06).
3. Bolt the left collector support bar to the collector adding the upper bag support as shown (Fig. 07).



Fig. 06



Fig. 07

Assembly Continued

Installing the 5" Hose

Locate the 5" hose and two hose clamps.

1. Slip a hose clamp over both ends of the hose (A--Fig. 08).
- 3.) Place one end of the hose over the 5" outlet on the fan housing and the other end on the collector. (Fig. 08).
- 4.) Tighten the clamps with a slotted screwdriver or wrench.

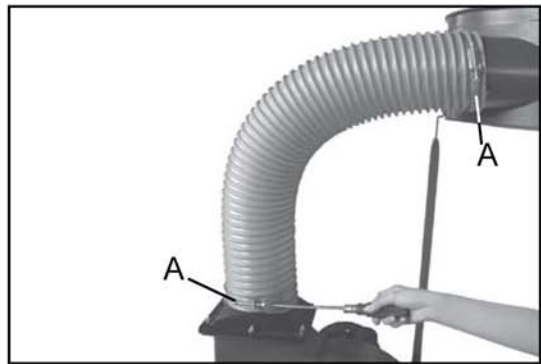

Fig. 08

Threading Band Straps in Filter Bags

- 1.) Unfold both bags and lay on a flat surface.
- 2.) Locate the slit on the right side of the top lip of each bag.
- 3.) Start the slotted catch end of the band strap through the right slit (Fig. 09).
- 4.) Work the strap around the inside of the bag until it emerges through the slot on the left side.

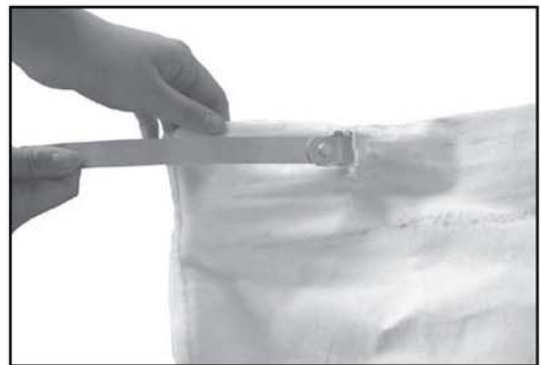

Fig. 09

Installing Filter Bags to the Collector Housing

- 1.) Place a plastic liner inside the lower filter bag and slide both over the bottom of the collector housing
- 2.) Engage the catch end of the strap with the clasp in the appropriate slot to ensure a tight fit (Fig. 10).
- 3.) Press the lever with the palm of your hand to lock the clamp.
- 4.) To release the clamp, lift up on the lever. If the lever is hard to disengage simply use a flat head screwdriver to pry the lever upwards.
- 5.) Hang the upper bag from the hook on the upper bag support. The upper bag does not use a plastic liner.

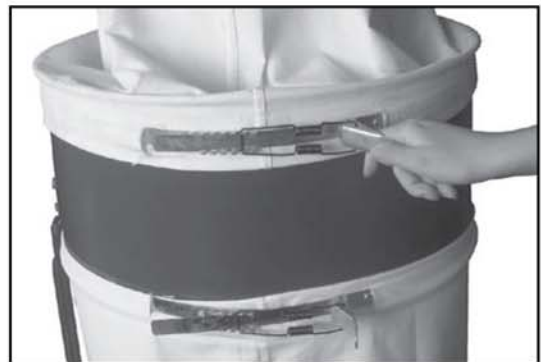

Fig. 10

Mounting the "Y" Inlet

1. Slide the "Y" inlet over the large opening on the fan housing. Secure with the supplied phillips head screw (Fig. 11).



Fig. 11

Grounding the Duct Work

Dust particles moving through flexible or rigid plastic duct work can cause static electricity build-up. The duct work must be properly grounded to ensure that static discharge does not ignite fine dust particles causing an explosion or fire. Glass dust is a silicate and therefore not combustible. Grounding is not needed.

To properly ground plastic duct work simply run a small gauge bare copper wire through the ducting and have it emerge from the hose at the dust collector and at each dust producing machine. The bare copper wire should be bonded to the metal shell of each machine by means of a metal screw. The screw must be threaded into the metal shell to ensure a good connection.

The grounding of metal duct work is similar, the only difference is that there is no need to run the bare copper wire inside the ducting. It can be wrapped along the outside of the ducting and should be bonded to each machine as described above.

NOTE: When grinding material other than glass, always follow the grounding instructions above. Glass dust is a silicate and is not combustible so glass dust does not require grounding of the vacuum hoses.

Emptying and Cleaning the Dust Collector

Caution: Make sure that the dust collector is unplugged before cleaning or servicing.

Always wear a dust mask or respirator while emptying the collector bags or cleaning the dust collector. Please refer to the California Proposition 65 warning on page 3 of this manual regarding hazards from exposure to dust.

Troubleshooting

Symptom	Possible Cause	Solution
High collector pressure drop	1. Malfunction of bag cleaning System 2. Ineffective cleaning 3. Re-entrainment of dust in collector due to low density 4. Wetting of bags	1. Check all cleaning system components 2. Clean bags or replace 3. Check discharge valves Lower A/C Ratio 4. Control dew point excursions Dry bags with clean air Clean bags or replace
Stack emission	1. Bag permeability increase 2. Clean to dirty plenum leakage 3. Change of inlet conditions	1. Test bag or replace 2. Inspect and repair 3. Test & Review
Puffing back	1. High pressure drop across the bag house 2. Plugged duct lines 3. Poor hood design	1. See above 2. Clean out 3. Evaluate temporary modifications and implement
Loud or unusual noises	1. Vibrations 2. Banging of moving parts	1. Tighten all components or lay base stable 2. Tighten all parts or components

Parts List

Key No.	Description	Key No.	Description
1	Caster	21	Screw
3	Base plate	22	Impeller
4	Flat washer	23	Cap head nut
5	Motor base	24	Inlet
6	Hex bolt	25	Fan housing cover
7	Motor cable	26	Screw
8	Motor	27	Flat washer
9	Switch body	28	Hex bolt
10	Center key	29	Rubber gasket
13	Upper bag support	30	5" Outlet
14	Collector support	31	Hose clamp
15	Hex bolt	32	5" Hose
16	Hex nut	33	Collector
17	Key	34	Strap
18	Fan washer	35	Filter bag
20	Flat washer	36	Dust bag
		37	Fan housing

Parts Explosion

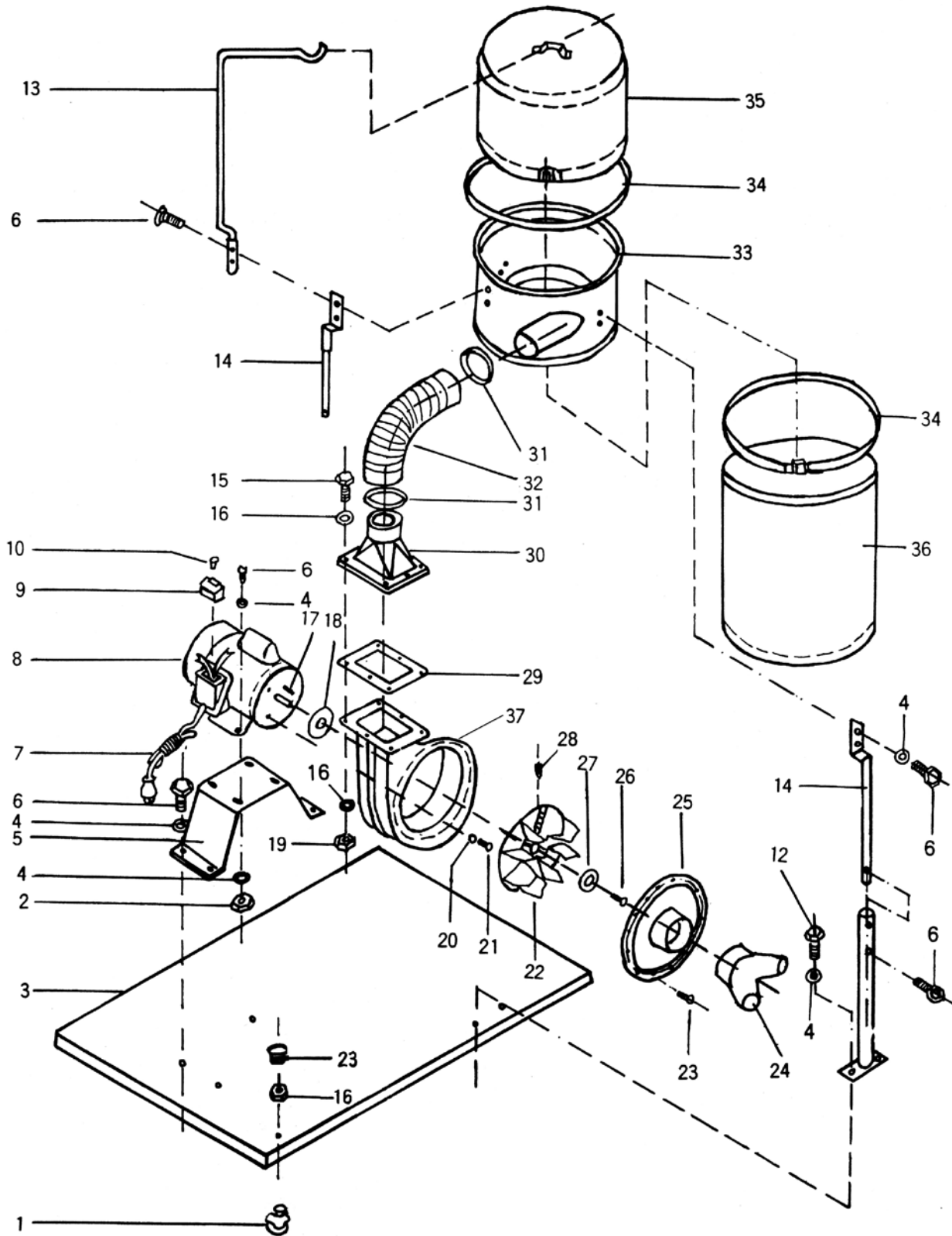

Electrical Schematic Diagram

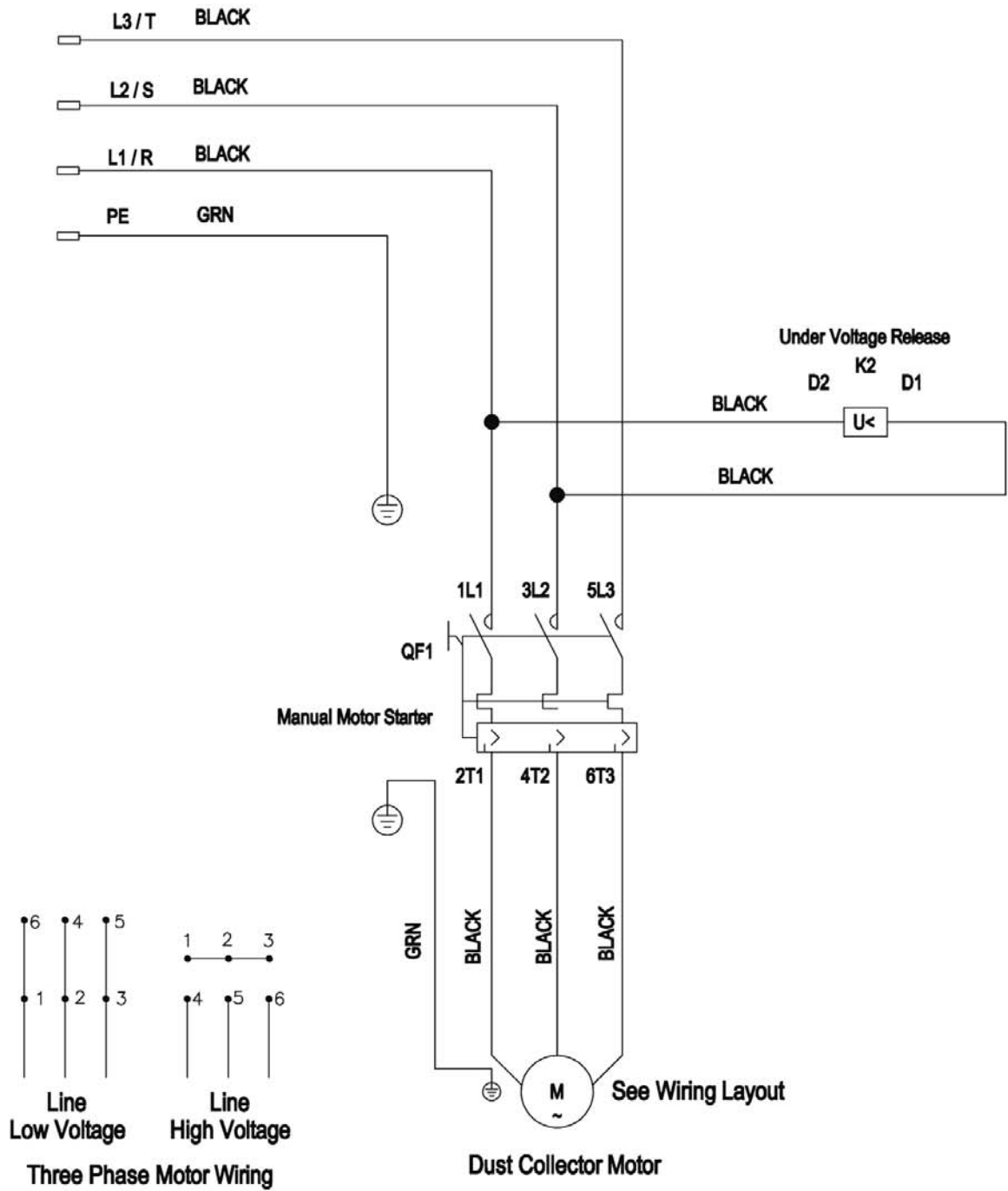

Note:

1. Power to be supplied by customer.
2. Wires must be 14AWG or a cross sectional area of 2.08mm²
3. Leads terminating to the Motor Starter or the Under Voltage Release must be equipped with a ferrule. Use ring lugs on the motor wiring.
4. Put electrical tape on all Motor Lug connections.
5. Tyrap cord to the underside of the ball caster roller table.